

Click to view price, real time Inventory,  
Delivery & Lifecycle Information ;

# RC4580QDRQ1

Texas instruments

Audio Amplifiers Dual Audio Op Amp

Any questions, please feel free to contact us.  
[info@kaimte.com](mailto:info@kaimte.com)

## DUAL AUDIO OPERATIONAL AMPLIFIER

Check for Samples: [RC4580-Q1](#)

### FEATURES

- **Qualified for Automotive Applications**
- **AEC-Q100 Qualified With the Following Results:**
  - **Device Temperature Grade 1: –40°C to 125°C Ambient Operating Temperature Range**
  - **Device HBM ESD Classification Level H2**
  - **Device CDM ESD Classification Level C3B**
- **Operating Voltage . . . ±2 V to ±18 V**
- **Low Noise Voltage . . . 0.8  $\mu$ Vrms (TYP)**
- **Wide GBW . . . 12 MHz (TYP)**
- **Low THD . . . 0.0005% (TYP)**
- **Slew Rate . . . 5 V/ $\mu$ s (TYP)**
- **Suitable for Automotive Applications Such As Audio Pre-amplifier, Active Filter, Headphone Amplifier, Industrial Measurement Equipment**
- **Drop-In Replacement for NJM4580**
- **Pin and Function Compatible With LM833, NE5532, NJM4558/9, and NJM4560/2/5**

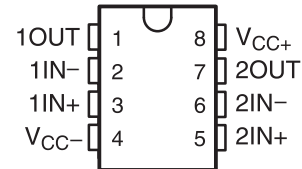
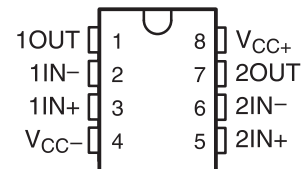
**D PACKAGE  
SOIC – 8  
(TOP VIEW)**

**PW PACKAGE  
TSSOP – 8  
(TOP VIEW)**

### DESCRIPTION

The RC4580-Q1 device is a dual operational amplifier that is designed optimally for audio applications, such as improving tone control. It offers low noise, high gain bandwidth, low harmonic distortion, and high output current. All of these features make the device ideally suited for audio electronics, such as audio preamplifiers and active filters, as well as industrial measurement equipment. When high output current is required, the RC4580-Q1 device can be used as a headphone amplifier. Due to its wide operating supply voltage, the RC4580-Q1 device can also be used in low-voltage applications.

### ORDERING INFORMATION<sup>(1)</sup>

$T_A$	PACKAGE <sup>(2)</sup>		ORDERABLE PART NUMBER	TOP-SIDE MARKING
–40°C to 125°C	SOIC – D	Reel of 2000	RC4580QDRQ1	R4580Q
–40°C to 125°C	TSSOP - PW	Reel of 2000	RC4580QPWRQ1	R4580Q

(1) For the most current package and ordering information, see the Package Option Addendum at the end of this document, or see the TI web site at [www.ti.com](http://www.ti.com).

(2) Package drawings, thermal data, and symbolization are available at [www.ti.com/packaging](http://www.ti.com/packaging).



Please be aware that an important notice concerning availability, standard warranty, and use in critical applications of Texas Instruments semiconductor products and disclaimers thereto appears at the end of this data sheet.

PRODUCTION DATA information is current as of publication date. Products conform to specifications per the terms of the Texas Instruments standard warranty. Production processing does not necessarily include testing of all parameters.

Copyright © 2010–2012, Texas Instruments Incorporated



This integrated circuit can be damaged by ESD. Texas Instruments recommends that all integrated circuits be handled with appropriate precautions. Failure to observe proper handling and installation procedures can cause damage.

ESD damage can range from subtle performance degradation to complete device failure. Precision integrated circuits may be more susceptible to damage because very small parametric changes could cause the device not to meet its published specifications.

Figure 1. EQUIVALENT SCHEMATIC

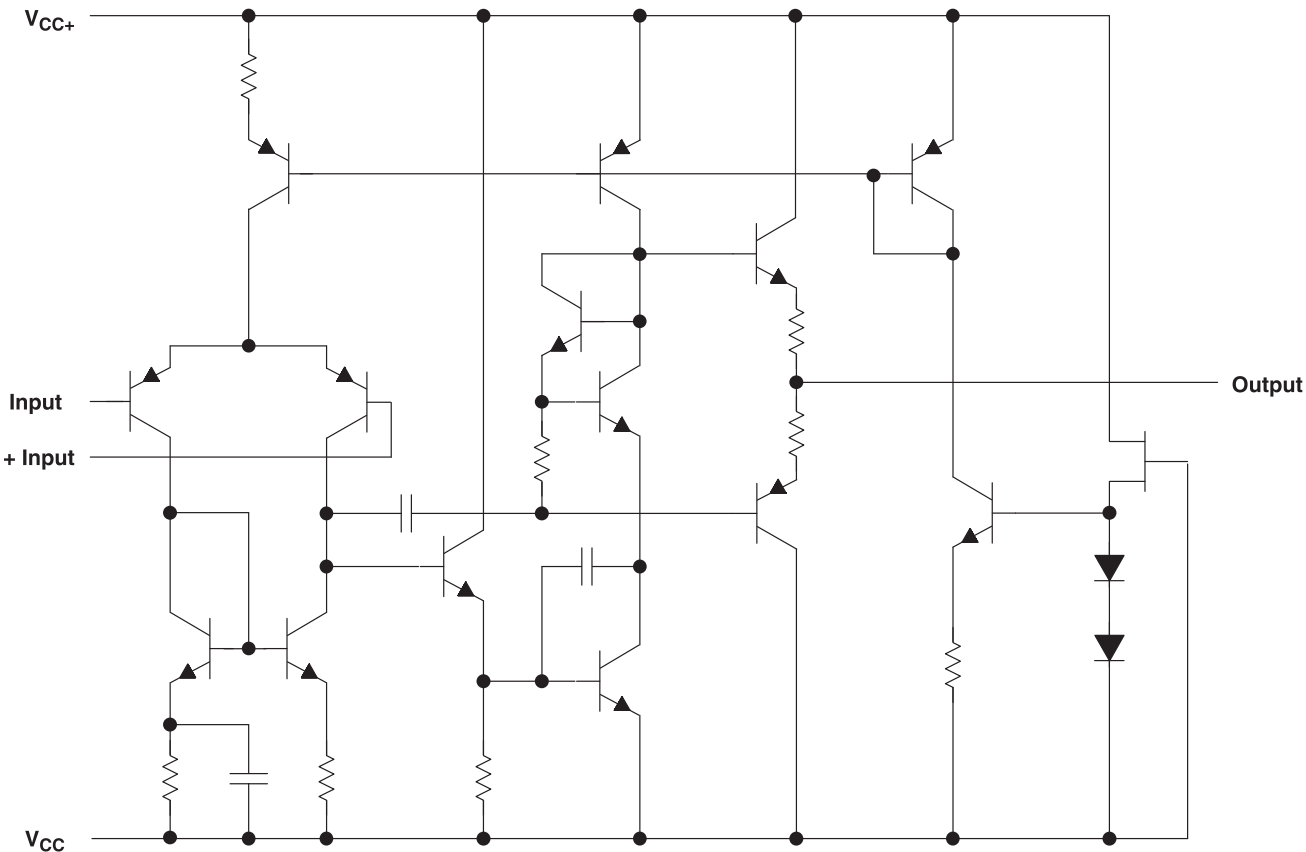

**ABSOLUTE MAXIMUM RATINGS<sup>(1)</sup>**

over operating free-air temperature range (unless otherwise noted)

		MIN	MAX	UNIT
$V_{CC}$	Supply voltage		±18	V
	Input voltage (any input)		±15	V
$V_{ID}$	Differential input voltage		±30	V
	Output current		±50	mA
$T_A$	Ambient temperature range	-40	125	°C
$T_{stg}$	Storage temperature range	-60	125	°C
Electrostatic Discharge (ESD) Ratings	Human-body model (HBM) AEC-Q100 Classification Level H2		2	kV
	Charged-device model (CDM) AEC-Q100 Classification Level C3B		750	V

(1) Stresses beyond those listed under *Absolute Maximum Ratings* may cause permanent damage to the device. These are stress ratings only, and functional operation of the device at these or any other conditions beyond those indicated under *Recommended Operating Conditions* is not implied. Exposure to absolute-maximum-rated conditions for extended periods may affect device reliability.

## THERMAL INFORMATION

THERMAL METRIC <sup>(1)</sup>		RC4580-Q1		UNIT
		D (8 PINS)	PW (8 PINS)	
$\theta_{JA}$	Junction-to-ambient thermal resistance	109	163	°C/W
$\theta_{JcTop}$	Junction-to-case (top) thermal resistance	55.7	38	
$\theta_{JB}$	Junction-to-board thermal resistance	49	90.6	
$\Psi_{JT}$	Junction-to-top characterization parameter	10.6	1.3	
$\Psi_{JB}$	Junction-to-board characterization parameter	48.6	88.9	
$\theta_{JcBot}$	Junction-to-case (bottom) thermal resistance	n/a	n/a	

(1) For more information about traditional and new thermal metrics, see the *IC Package Thermal Metrics* application report, [SPRA953](#).

## RECOMMENDED OPERATING CONDITIONS

		MIN	MAX	UNIT
$V_{CC+}$	Supply voltage	2	16	V
$V_{CC-}$		-2	-16	
$V_{ICR}$	Input common-mode voltage range	-13.5	13.5	V
$T_A$	Operating free-air temperature	-40	125	°C

## ELECTRICAL CHARACTERISTICS

$V_{CC\pm} = \pm 15$  V,  $T_A = -40^\circ\text{C}$  to  $125^\circ\text{C}$  (unless otherwise noted)

PARAMETER		TEST CONDITIONS	MIN	TYP	MAX	UNIT
$V_{IO}$	Input offset voltage	$R_S = < 10$ k $\Omega$		0.5	3	mV
$I_{IO}$	Input offset current			5	200	nA
$I_{IB}$	Input bias current			100	500	nA
$A_{VD}$	Large-signal differential voltage amplification	$R_L \geq 2$ k $\Omega$ , $V_O = \pm 10$ V	90	110		dB
$V_{CM}$	Output voltage swing	$R_L \geq 2$ k $\Omega$	$\pm 12$	$\pm 13.5$		V
$V_{ICR}$	Common-mode input voltage		$\pm 12$	$\pm 13.5$		V
CMRR	Common-mode rejection ratio	$R_S \leq 10$ k $\Omega$	80	110		dB
$k_{SVR}$	Supply-voltage rejection ratio <sup>(1)</sup>	$R_S \leq 10$ k $\Omega$	80	110		dB
$I_{CC}$	Total supply current (all amplifiers)			6	9	mA

(1) Measured with  $V_{CC\pm}$  varied simultaneously

## OPERATING CHARACTERISTICS

$V_{CC\pm} = \pm 15$  V,  $T_A = -40^\circ\text{C}$  to  $125^\circ\text{C}$  (unless otherwise noted)

PARAMETER		TEST CONDITIONS	TYP	UNIT
SR	Slew rate at unity gain	$R_L \geq 2$ k $\Omega$	5	V/ $\mu$ s
GBW	Gain-bandwidth product	$f = 10$ kHz	12	MHz
THD	Total harmonic distortion	$V_O = 5$ V, $R_L = 2$ k $\Omega$ , $f = 1$ kHz, $A_{VD} = 20$ dB	0.0005%	
$V_n$	Equivalent input noise voltage	RIAA, $R_S \leq 2.2$ k $\Omega$ , 30-kHz LPF	0.8	$\mu$ Vrms

TYPICAL CHARACTERISTICS

MAXIMUM OUTPUT VOLTAGE SWING  
vs  
LOAD RESISTANCE

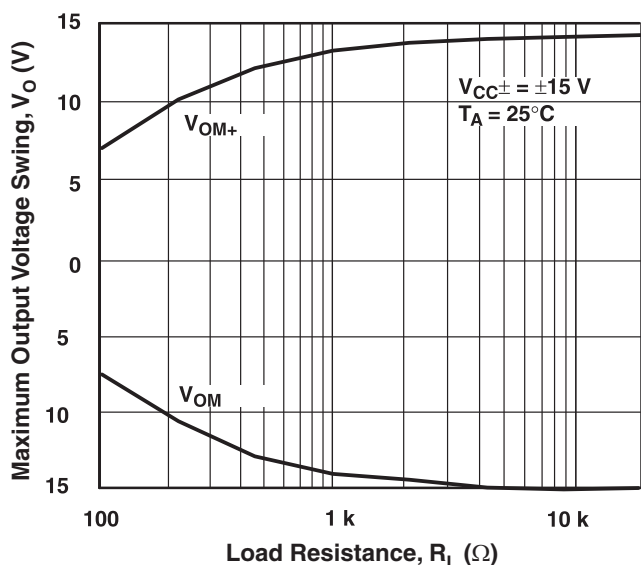

Figure 2.

MAXIMUM OUTPUT VOLTAGE SWING  
vs  
FREQUENCY

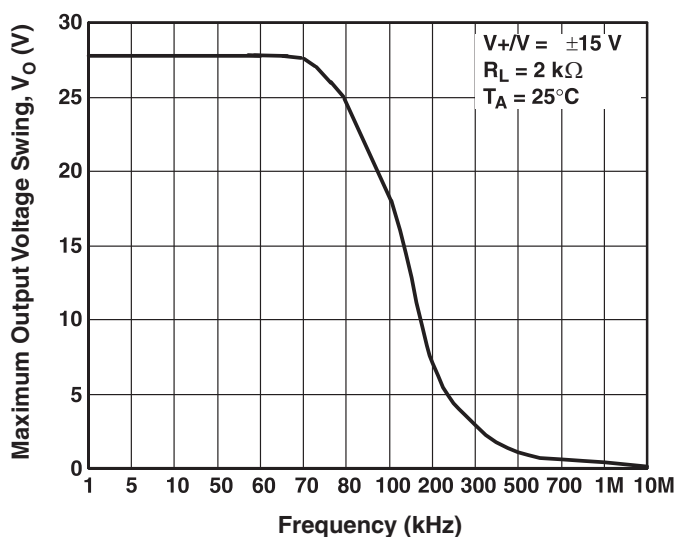

Figure 3.

OUTPUT VOLTAGE SWING  
vs  
OUTPUT CURRENT

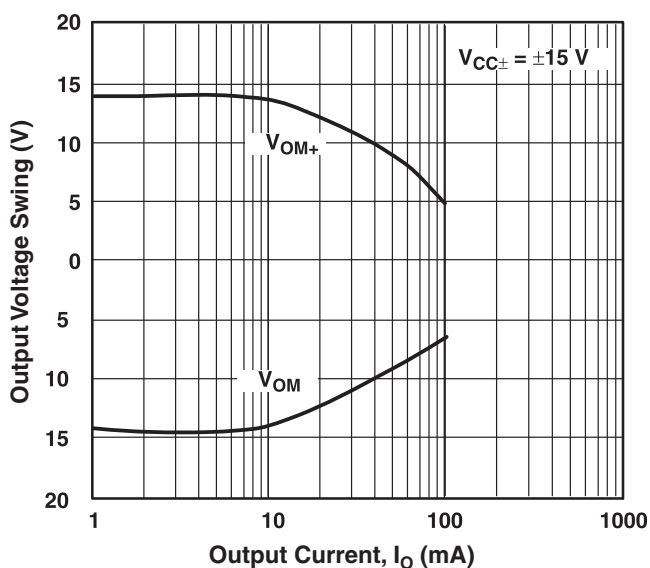

Figure 4.

EQUIVALENT INPUT NOISE VOLTAGE  
vs  
FREQUENCY

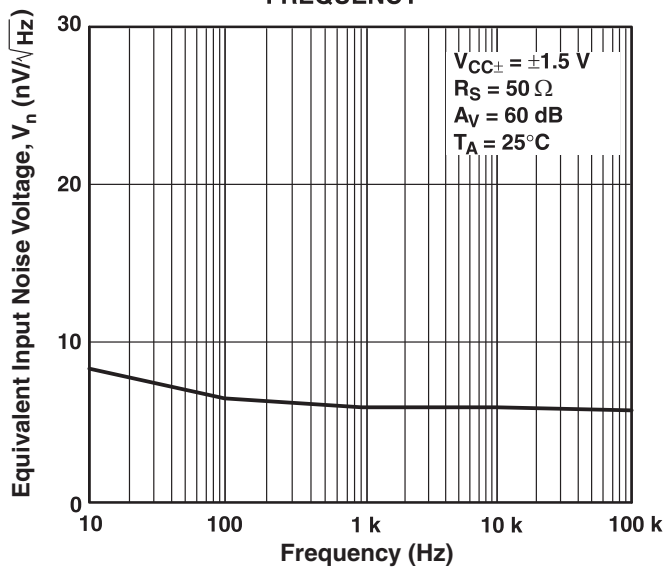

Figure 5.

TYPICAL CHARACTERISTICS (continued)

OPERATING CURRENT  
vs  
TEMPERATURE

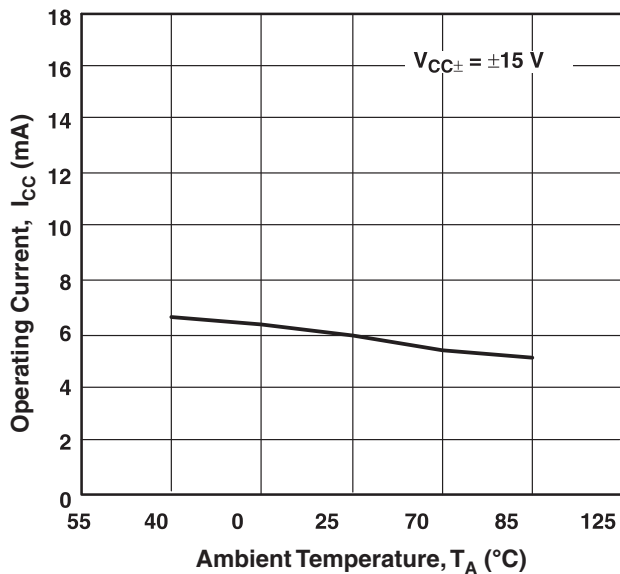

Figure 6.

OUTPUT VOLTAGE SWING  
vs  
TEMPERATURE

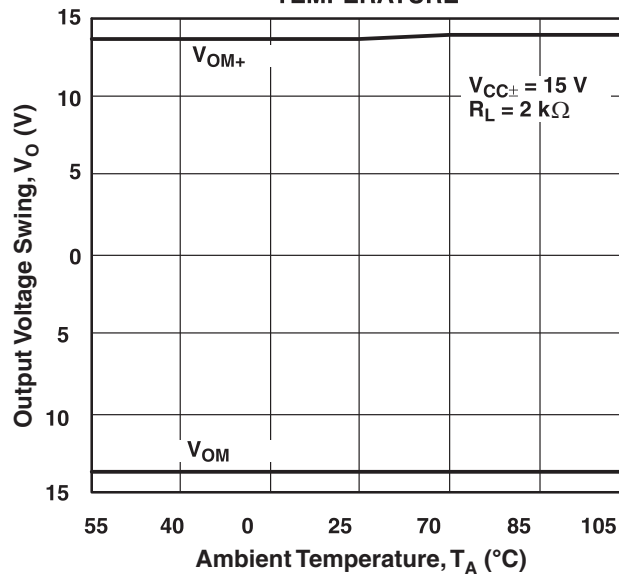

Figure 7.

INPUT OFFSET VOLTAGE  
vs  
TEMPERATURE

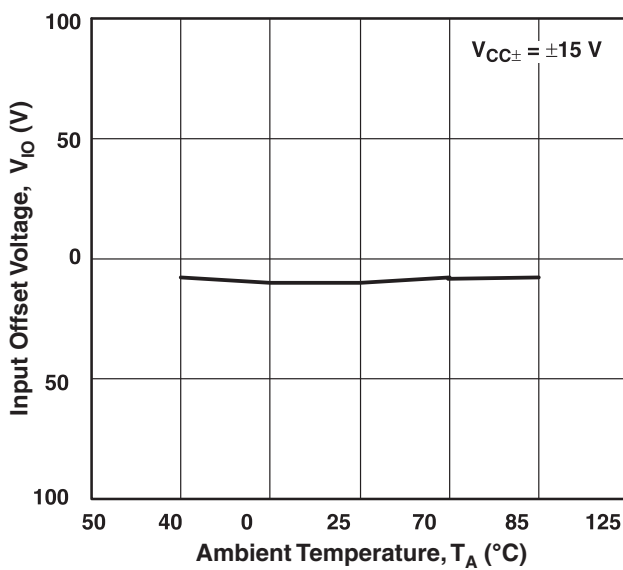

Figure 8.

INPUT BIAS CURRENT  
vs  
TEMPERATURE

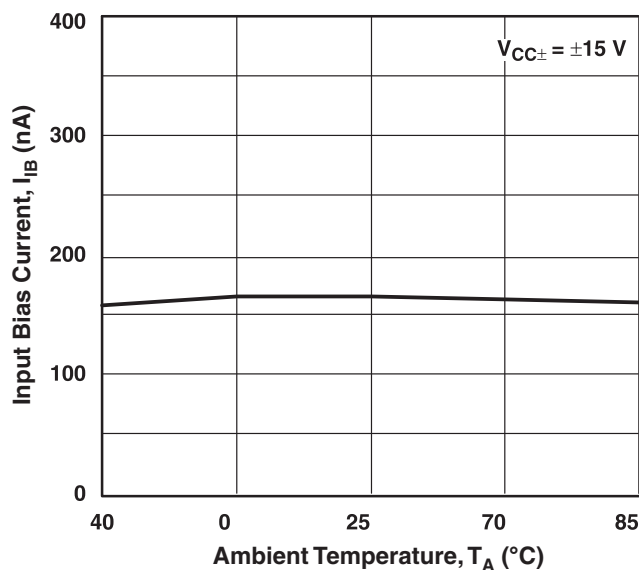

Figure 9.

**TYPICAL CHARACTERISTICS (continued)**

**MAXIMUM OUTPUT VOLTAGE SWING  
vs  
OPERATING VOLTAGE**

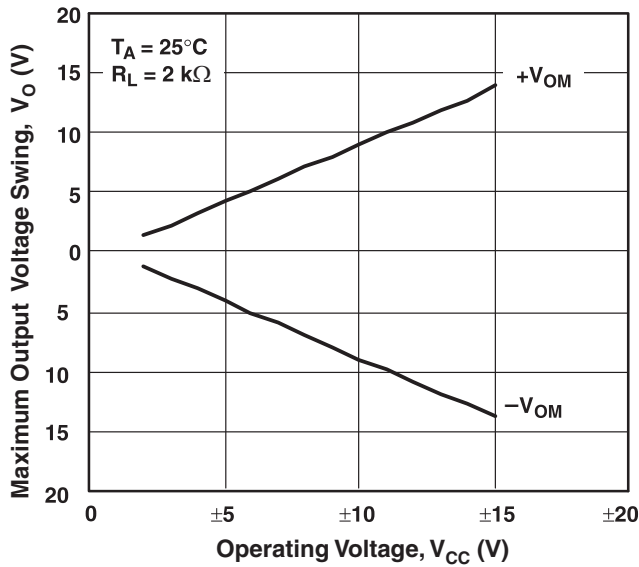

Figure 10.

**OPERATING CURRENT  
vs  
OPERATING VOLTAGE**

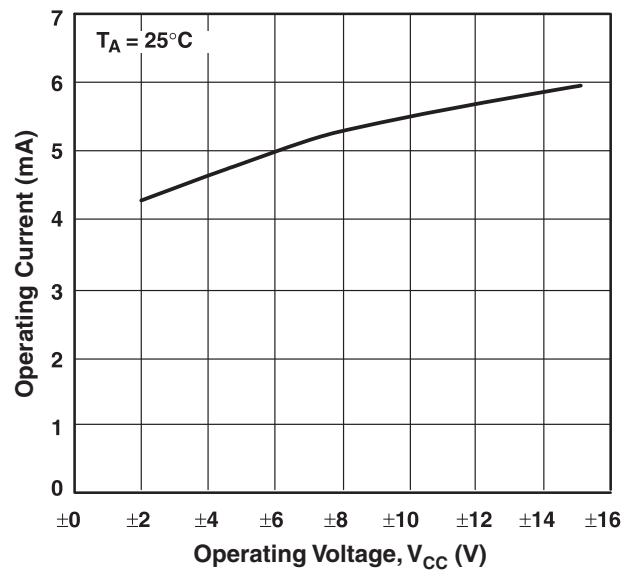

Figure 11.

**TOTAL HARMONIC DISTORTION  
vs  
OUTPUT VOLTAGE**

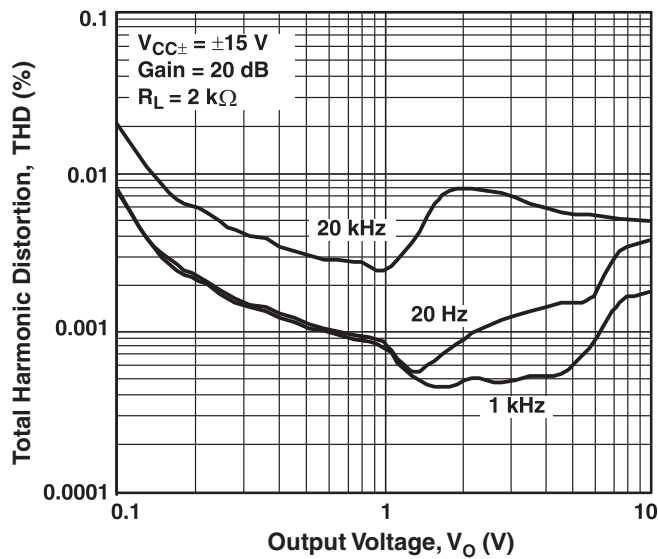

Figure 12.

**VOLTAGE GAIN, PHASE  
vs  
FREQUENCY**

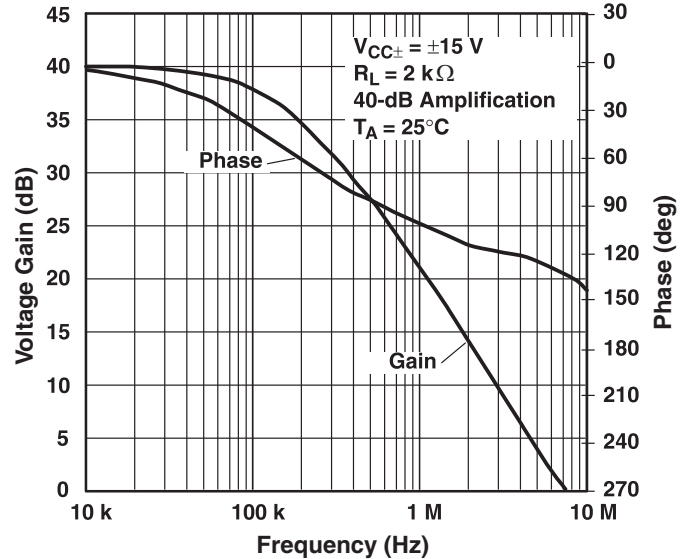

Figure 13.

## REVISION HISTORY

Changes from Original (December 2010) to Revision A	Page
• Added AEC-Q100 info to the features; changed Suitable for Applications to Suitable for Automotive Applications .....	1
• Added PW pinout drawing .....	1
• Added second row for PW package to Ordering Information table .....	1
• Added ESDS .....	2
• Changed $T_J$ to $T_A$ .....	2
• Removed $\theta_{JA}$ row from Abs Max table because it is also listed in the thermal table .....	2
• Added ESD ratings to Abs Max table .....	2
• Added thermal table .....	3
• Changed $T_A = 25^\circ\text{C}$ to $T_A = -40^\circ\text{C}$ to $125^\circ\text{C}$ in condition statement for Elec Char table and Op Char table .....	3



**PACKAGING INFORMATION**

Orderable Device	Status (1)	Package Type	Package Drawing	Pins	Package Qty	Eco Plan (2)	Lead finish/ Ball material (6)	MSL Peak Temp (3)	O
RC4580QDRQ1	ACTIVE	SOIC	D	8	2500	RoHS & Green	NIPDAU	Level-1-260C-UNLIM	
RC4580QPWRQ1	ACTIVE	TSSOP	PW	8	2000	RoHS & Green	NIPDAU	Level-1-260C-UNLIM	

(1) The marketing status values are defined as follows:

**ACTIVE:** Product device recommended for new designs.

**LIFEBUY:** TI has announced that the device will be discontinued, and a lifetime-buy period is in effect.

**NRND:** Not recommended for new designs. Device is in production to support existing customers, but TI does not recommend using this part in a new design.

**PREVIEW:** Device has been announced but is not in production. Samples may or may not be available.

**OBSOLETE:** TI has discontinued the production of the device.

(2) **RoHS:** TI defines "RoHS" to mean semiconductor products that are compliant with the current EU RoHS requirements for all 10 RoHS substances, including but not limited to lead (Pb). All RoHS substances must not exceed 0.1% by weight in homogeneous materials. Where designed to be soldered at high temperatures, "RoHS" products are suitable for use in applications that require high-temperature soldering reference these types of products as "Pb-Free".

**RoHS Exempt:** TI defines "RoHS Exempt" to mean products that contain lead but are compliant with EU RoHS pursuant to a specific EU RoHS exemption.

**Green:** TI defines "Green" to mean the content of Chlorine (Cl) and Bromine (Br) based flame retardants meet JS709B low halogen requirements of <=1000ppm. All other flame retardants must also meet the <=1000ppm threshold requirement.

(3) MSL, Peak Temp. - The Moisture Sensitivity Level rating according to the JEDEC industry standard classifications, and peak solder temperature.

(4) There may be additional marking, which relates to the logo, the lot trace code information, or the environmental category on the device.

(5) Multiple Device Markings will be inside parentheses. Only one Device Marking contained in parentheses and separated by a "~" will appear on a device. If a line of the previous line and the two combined represent the entire Device Marking for that device.

(6) Lead finish/Ball material - Orderable Devices may have multiple material finish options. Finish options are separated by a vertical ruled line. Lead finish/Ball material options are limited to a maximum of six lines if the finish value exceeds the maximum column width.

**Important Information and Disclaimer:** The information provided on this page represents TI's knowledge and belief as of the date that it is provided. TI bases its information on information provided by third parties, and makes no representation or warranty as to the accuracy of such information. Efforts are underway to better integrate information from third parties and TI continues to take reasonable steps to provide representative and accurate information but may not have conducted destructive testing or chemical analysis on all devices. TI and TI suppliers consider certain information to be proprietary, and thus CAS numbers and other limited information may not be available for release.

In no event shall TI's liability arising out of such information exceed the total purchase price of the TI part(s) at issue in this document sold by TI to Customer on the date of purchase.

**OTHER QUALIFIED VERSIONS OF RC4580-Q1 :**

- Catalog: [RC4580](#)

NOTE: Qualified Version Definitions:

- Catalog - TI's standard catalog product

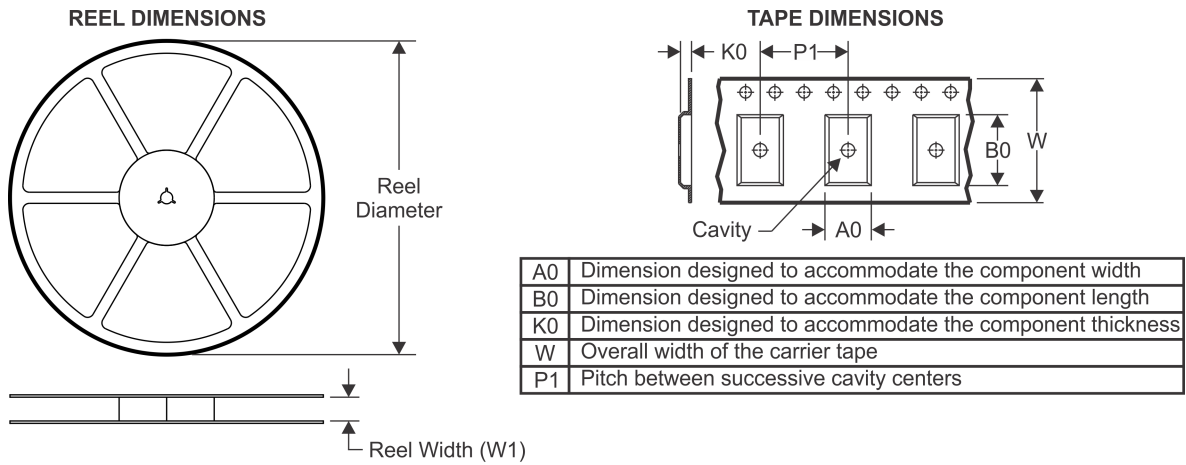
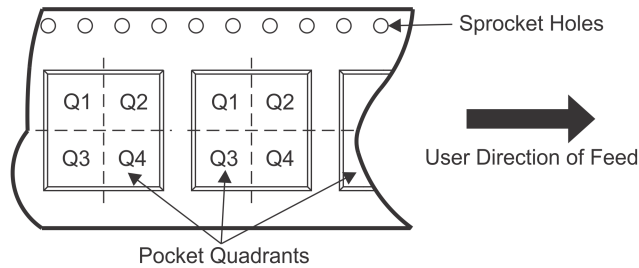
**TAPE AND REEL INFORMATION**

**QUADRANT ASSIGNMENTS FOR PIN 1 ORIENTATION IN TAPE**

\*All dimensions are nominal

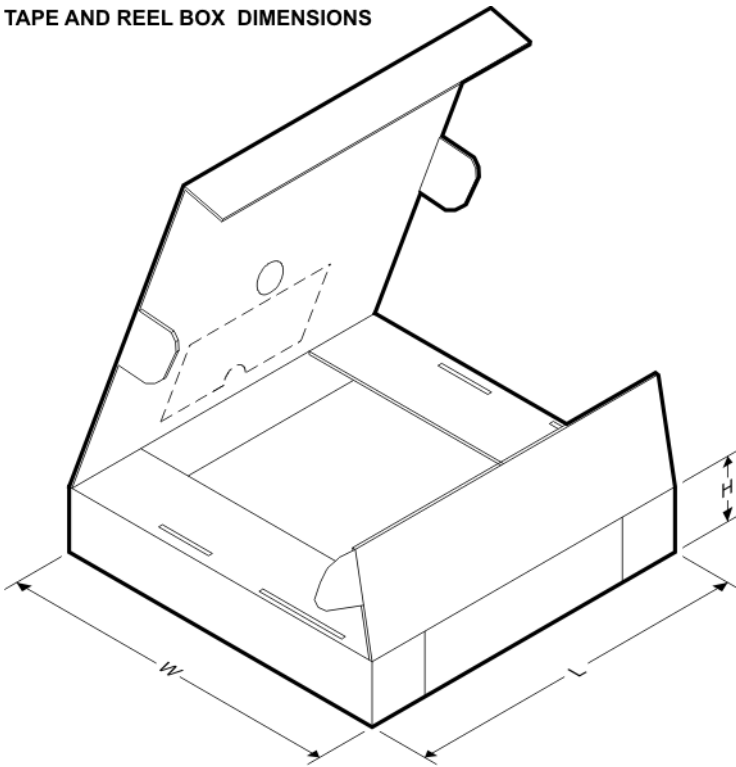
Device	Package Type	Package Drawing	Pins	SPQ	Reel Diameter (mm)	Reel Width W1 (mm)	A0 (mm)	B0 (mm)	K0 (mm)	P1 (mm)	W (mm)	Pin1 Quadrant
RC4580QDRQ1	SOIC	D	8	2500	330.0	12.4	6.4	5.2	2.1	8.0	12.0	Q1
RC4580QPWRQ1	TSSOP	PW	8	2000	330.0	12.4	7.0	3.6	1.6	8.0	12.0	Q1

**TAPE AND REEL BOX DIMENSIONS**

\*All dimensions are nominal

Device	Package Type	Package Drawing	Pins	SPQ	Length (mm)	Width (mm)	Height (mm)
RC4580QDRQ1	SOIC	D	8	2500	340.5	336.1	25.0
RC4580QPWRQ1	TSSOP	PW	8	2000	853.0	449.0	35.0

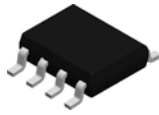

D0008A

# PACKAGE OUTLINE

SOIC - 1.75 mm max height

SMALL OUTLINE INTEGRATED CIRCUIT

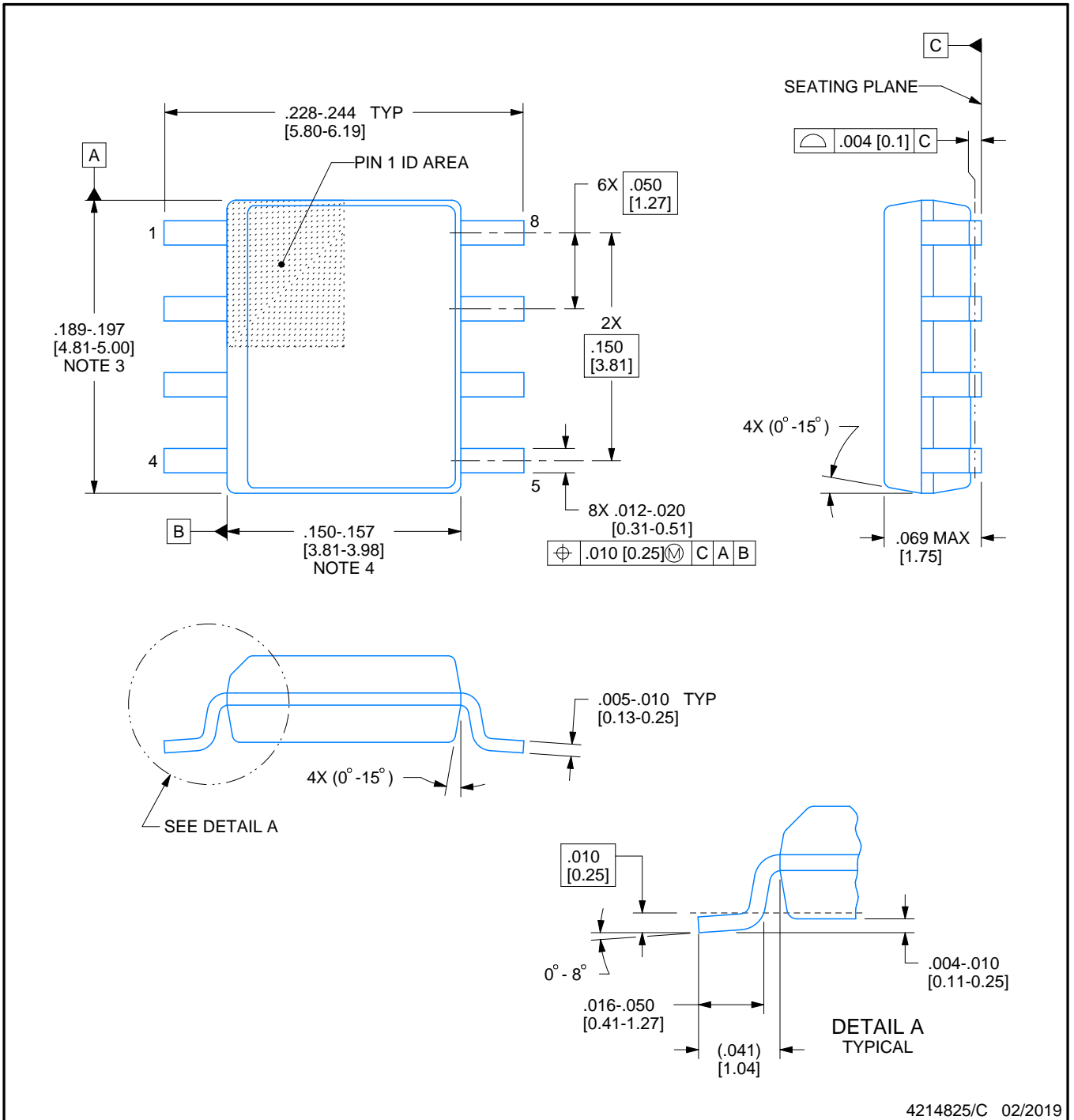

4214825/C 02/2019

NOTES:

- Linear dimensions are in inches [millimeters]. Dimensions in parenthesis are for reference only. Controlling dimensions are in inches. Dimensioning and tolerancing per ASME Y14.5M.
- This drawing is subject to change without notice.
- This dimension does not include mold flash, protrusions, or gate burrs. Mold flash, protrusions, or gate burrs shall not exceed  $.006$  [0.15] per side.
- This dimension does not include interlead flash.
- Reference JEDEC registration MS-012, variation AA.

# EXAMPLE BOARD LAYOUT

D0008A

SOIC - 1.75 mm max height

SMALL OUTLINE INTEGRATED CIRCUIT

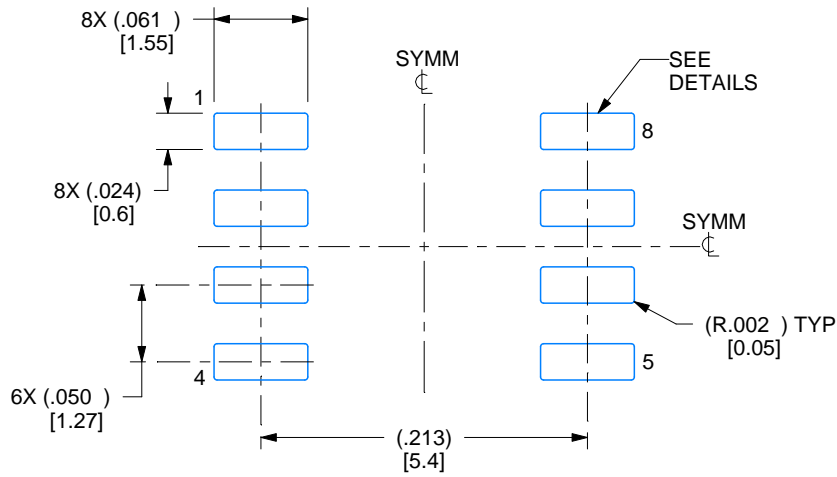

LAND PATTERN EXAMPLE  
EXPOSED METAL SHOWN  
SCALE:8X

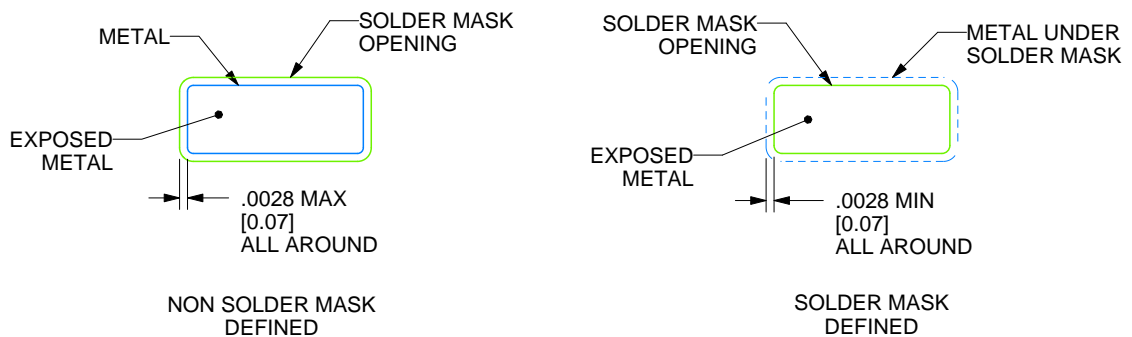

SOLDER MASK DETAILS

4214825/C 02/2019

NOTES: (continued)

6. Publication IPC-7351 may have alternate designs.

7. Solder mask tolerances between and around signal pads can vary based on board fabrication site.

# EXAMPLE STENCIL DESIGN

D0008A

SOIC - 1.75 mm max height

SMALL OUTLINE INTEGRATED CIRCUIT

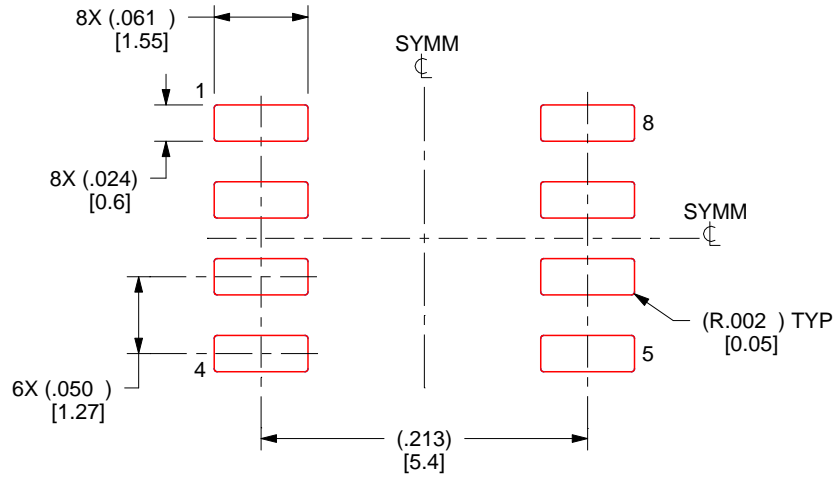

SOLDER PASTE EXAMPLE  
BASED ON .005 INCH [0.125 MM] THICK STENCIL  
SCALE:8X

4214825/C 02/2019

NOTES: (continued)

8. Laser cutting apertures with trapezoidal walls and rounded corners may offer better paste release. IPC-7525 may have alternate design recommendations.
9. Board assembly site may have different recommendations for stencil design.

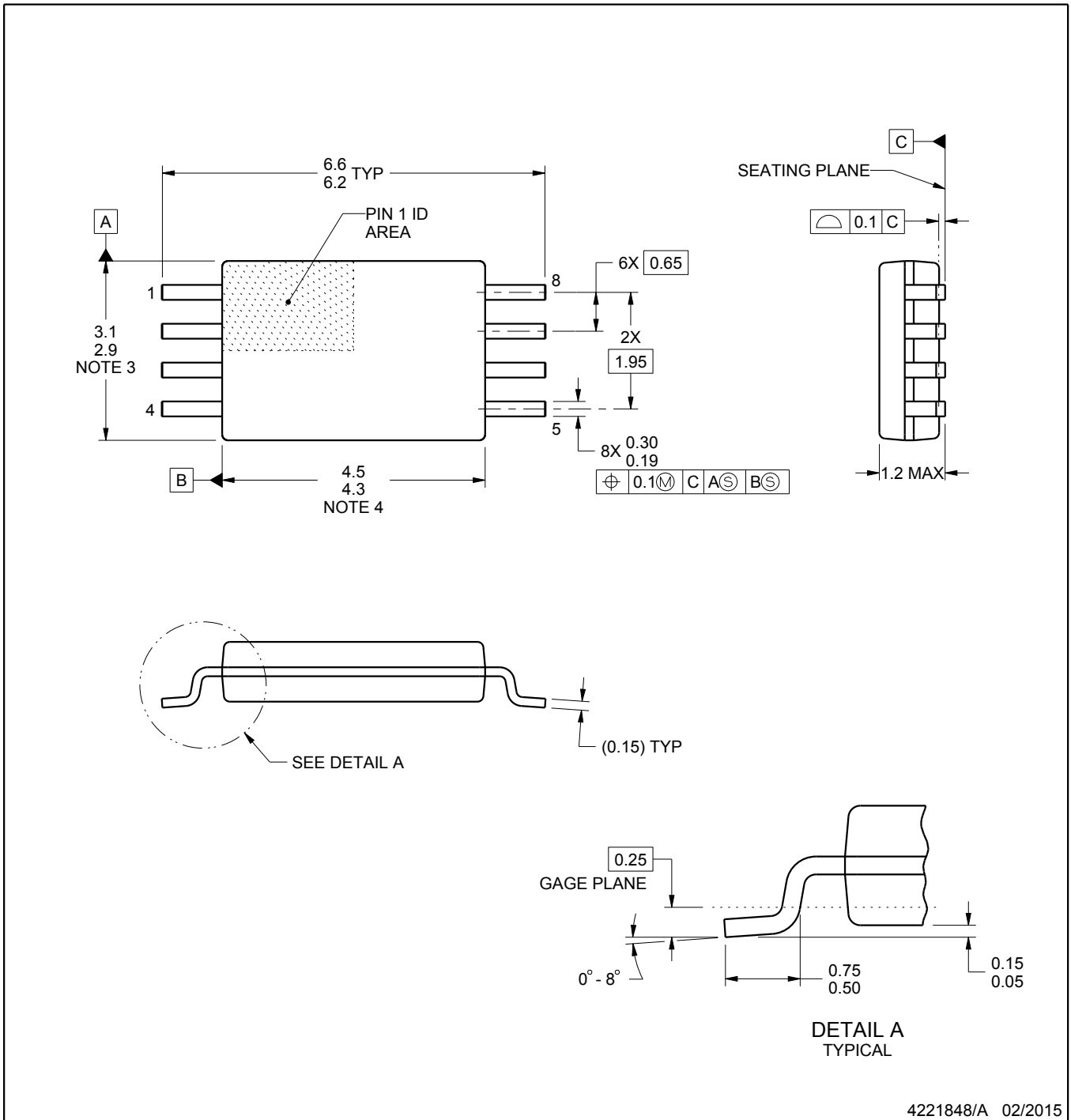

4221848/A 02/2015

NOTES:

1. All linear dimensions are in millimeters. Any dimensions in parenthesis are for reference only. Dimensioning and tolerancing per ASME Y14.5M.
2. This drawing is subject to change without notice.
3. This dimension does not include mold flash, protrusions, or gate burrs. Mold flash, protrusions, or gate burrs shall not exceed 0.15 mm per side.
4. This dimension does not include interlead flash. Interlead flash shall not exceed 0.25 mm per side.
5. Reference JEDEC registration MO-153, variation AA.



# EXAMPLE BOARD LAYOUT

PW0008A

TSSOP - 1.2 mm max height

SMALL OUTLINE PACKAGE

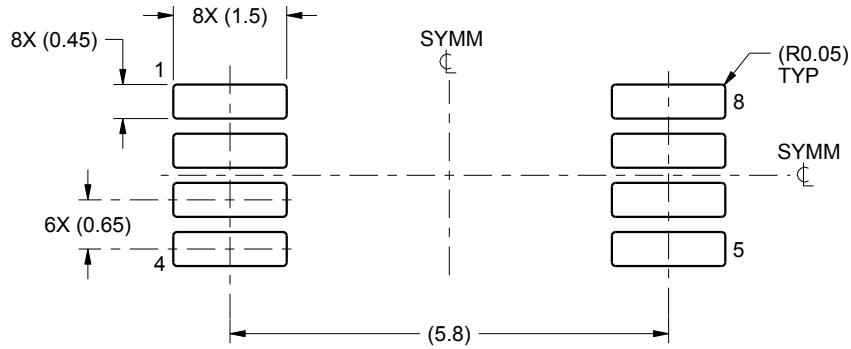

LAND PATTERN EXAMPLE  
SCALE:10X

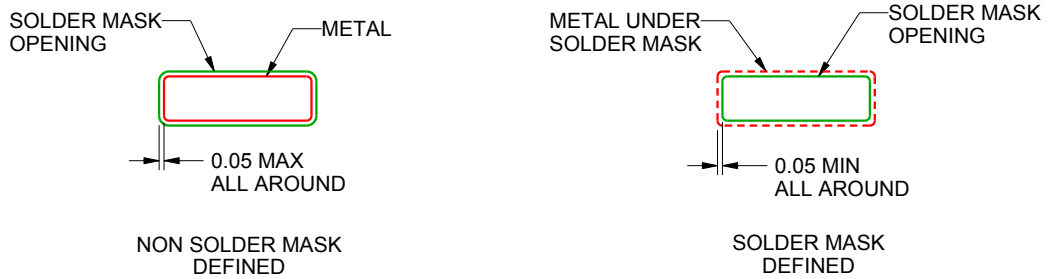

SOLDER MASK DETAILS  
NOT TO SCALE

4221848/A 02/2015

NOTES: (continued)

6. Publication IPC-7351 may have alternate designs.

7. Solder mask tolerances between and around signal pads can vary based on board fabrication site.

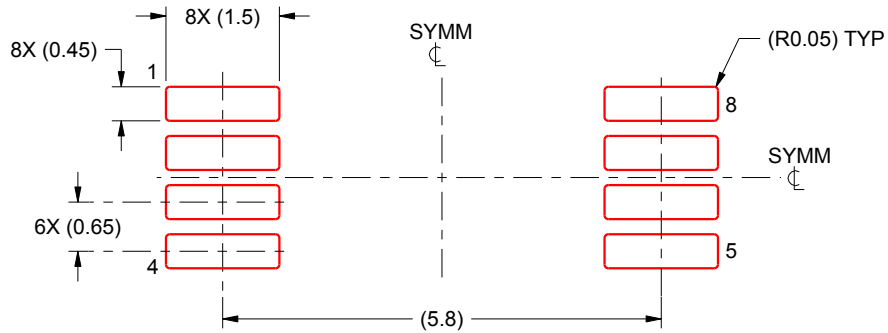

SOLDER PASTE EXAMPLE  
BASED ON 0.125 mm THICK STENCIL  
SCALE:10X

4221848/A 02/2015

NOTES: (continued)

8. Laser cutting apertures with trapezoidal walls and rounded corners may offer better paste release. IPC-7525 may have alternate design recommendations.
9. Board assembly site may have different recommendations for stencil design.

## IMPORTANT NOTICE AND DISCLAIMER

TI PROVIDES TECHNICAL AND RELIABILITY DATA (INCLUDING DATASHEETS), DESIGN RESOURCES (INCLUDING REFERENCE DESIGNS), APPLICATION OR OTHER DESIGN ADVICE, WEB TOOLS, SAFETY INFORMATION, AND OTHER RESOURCES “AS IS” AND WITH ALL FAULTS, AND DISCLAIMS ALL WARRANTIES, EXPRESS AND IMPLIED, INCLUDING WITHOUT LIMITATION ANY IMPLIED WARRANTIES OF MERCHANTABILITY, FITNESS FOR A PARTICULAR PURPOSE OR NON-INFRINGEMENT OF THIRD PARTY INTELLECTUAL PROPERTY RIGHTS.

These resources are intended for skilled developers designing with TI products. You are solely responsible for (1) selecting the appropriate TI products for your application, (2) designing, validating and testing your application, and (3) ensuring your application meets applicable standards, and any other safety, security, or other requirements. These resources are subject to change without notice. TI grants you permission to use these resources only for development of an application that uses the TI products described in the resource. Other reproduction and display of these resources is prohibited. No license is granted to any other TI intellectual property right or to any third party intellectual property right. TI disclaims responsibility for, and you will fully indemnify TI and its representatives against, any claims, damages, costs, losses, and liabilities arising out of your use of these resources.

TI's products are provided subject to TI's Terms of Sale (<https://www.ti.com/legal/termsofsale.html>) or other applicable terms available either on [ti.com](https://www.ti.com) or provided in conjunction with such TI products. TI's provision of these resources does not expand or otherwise alter TI's applicable warranties or warranty disclaimers for TI products.

Mailing Address: Texas Instruments, Post Office Box 655303, Dallas, Texas 75265  
Copyright © 2021, Texas Instruments Incorporated