

Click to view price, real time Inventory,
Delivery & Lifecycle Information ;

XF3M-3015-1B

Omron Electronics

FFC & FPC Connectors RotaryBackLock .5mm Dual Contact 30pin

Any questions, please feel free to contact us.
info@kaimte.com

Rotary Backlock Connector (0.5-mm or 1.0-mm pitch, Dual Contact)

XF3M

Rotary Backlock Connectors Provide Improved Insertion of FPC/FFC Cables and Confirm Proper Connection with a Sure Lock Feel.

- Models available with 0.5 mm or 1.0 mm pitch.
- Dual contact design reduces the number of parts in the Bill of Materials.
- Applicable FPC/FFC thickness of 0.3 mm.
- Halogen Free (See note)

Note: OMRON uses the following standard to determine halogen-free construction: 900 ppm max. for Br, 900 ppm max. for Cl, and 1,500 ppm max. for Br+Cl.

- RoHS Compliant.

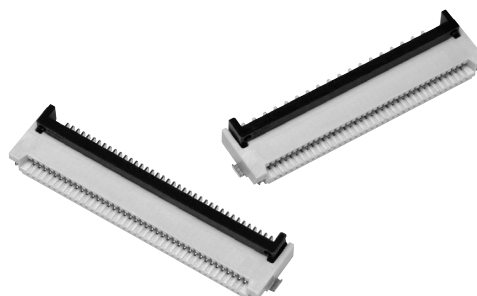

NEW

Ordering Information

0.5 mm Pitch

Pins	Model	Quantity per reel (See Note 2)
(4)	XF3M-0415-1B	1,500
(6)	XF3M-0615-1B	
(8)	XF3M-0815-1B	
10	XF3M-1015-1B	
12	XF3M-1215-1B	
(14)	XF3M-1415-1B	
16	XF3M-1615-1B	
(18)	XF3M-1815-1B	
20	XF3M-2015-1B	
(22)	XF3M-2215-1B	
24	XF3M-2415-1B	
25	XF3M-2515-1B	
(26)	XF3M-2615-1B	
30	XF3M-3015-1B	

Pins	Model	Quantity per reel (See Note 2)
31	XF3M-3115-1B	1,500
(32)	XF3M-3215-1B	
(33)	XF3M-3315-1B	
(34)	XF3M-3415-1B	
(35)	XF3M-3515-1B	
(36)	XF3M-3615-1B	
(38)	XF3M-3815-1B	
40	XF3M-4015-1B	
(41)	XF3M-4115-1B	
(42)	XF3M-4215-1B	
(45)	XF3M-4515-1B	
50	XF3M-5015-1B	
(55)	XF3M-5515-1B	
60	XF3M-6015-1B	

1.0 mm Pitch

Pins	Model	Quantity per reel (See Note 2)
4	XF3M(1)-0415-1B	1,500
5	XF3M(1)-0515-1B	
(6)	XF3M(1)-0615-1B	
(7)	XF3M(1)-0715-1B	
(8)	XF3M(1)-0815-1B	
(9)	XF3M(1)-0915-1B	
(10)	XF3M(1)-1015-1B	

Pins	Model	Quantity per reel (See Note 2)
12	XF3M(1)-1215-1B	1,500
15	XF3M(1)-1515-1B	
(16)	XF3M(1)-1615-1B	
(17)	XF3M(1)-1715-1B	
18	XF3M(1)-1815-1B	
(22)	XF3M(1)-2215-1B	
30	XF3M(1)-3015-1B	

- Note:**
1. Please consult your Omron representative for available pin count and marketing dates for pin counts in parenthesis.
 2. Please order by integer multiple of the quantity per reel. Add "-R100" at the end of the part to obtain reels of 100 pieces.

Ratings and Specifications

■ Characteristics

Rated current	0.5A AC/DC
Rated voltage	50V AC/DC
Contact resistance	50 mΩ max. (at 20 mVDC max., 100 mA max.)
Insulation resistance	100 MΩ min. (at 250 VDC)
Withstand voltage	250 VAC for 1 min. (leakage current: 1 mA max.)
Insertion tolerance	20 times
Ambient operating temperature	-30 to +85°C (with no icing or condensation)

■ Materials and Finish

Housing	LCP resin (UL94V-0)/natural
Slider	LCP resin (UL94V-0)/black
Contacts	Spring copper alloy/nickel substrate (1.5 μm), Gold-plated contacts (flash)
Hold-down	Copper alloy/fused-tin plating (1 μm)

Dimensions

Unit: mm

XF3M-□□15-1B (0.5 mm pitch)

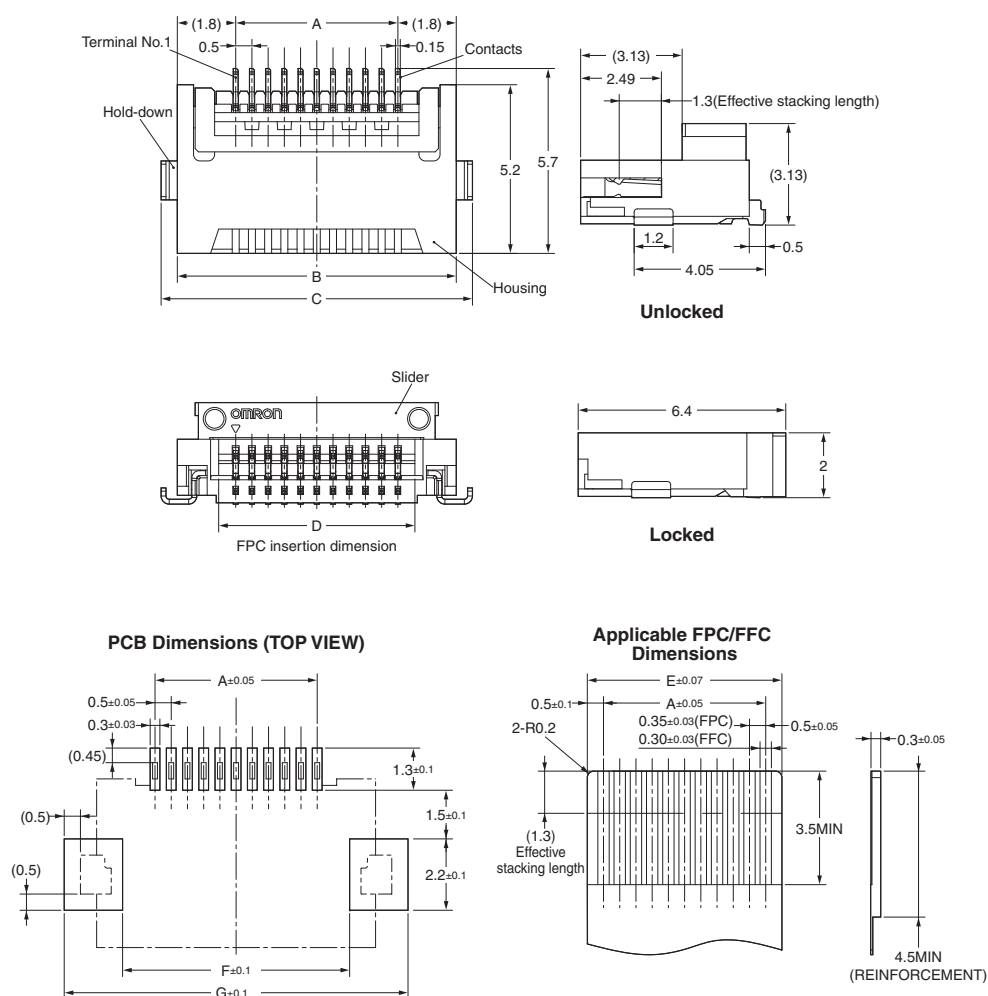

Table of Dimensions (0.5 mm pitch)

Pins	Model	A	B	C	D	E	F	G
(4)	XF3M-0415-1B	1.5	5.1	6.1	2.55	2.5	3.5	7.1
(6)	XF3M-0615-1B	2.5	6.1	7.1	3.55	3.5	4.5	8.1
(8)	XF3M-0815-1B	3.5	7.1	8.1	4.55	4.5	5.5	9.1
10	XF3M-1015-1B	4.5	8.1	9.1	5.55	5.5	6.5	10.1
12	XF3M-1215-1B	5.5	9.1	10.1	6.55	6.5	7.5	11.1
(14)	XF3M-1415-1B	6.5	10.1	11.1	7.55	7.5	8.5	12.1
16	XF3M-1615-1B	7.5	11.1	12.1	8.55	8.5	9.5	13.1
(18)	XF3M-1815-1B	8.5	12.1	13.1	9.55	9.5	10.5	14.1
20	XF3M-2015-1B	9.5	13.1	14.1	10.55	10.5	11.5	15.1
(22)	XF3M-2215-1B	10.5	14.1	15.1	11.55	11.5	12.5	16.1
24	XF3M-2415-1B	11.5	15.1	16.1	12.55	12.5	13.5	17.1
25	XF3M-2515-1B	12.0	15.6	16.6	13.05	13.0	14.0	17.6
(26)	XF3M-2615-1B	12.5	16.1	17.1	13.55	13.5	14.5	18.1
30	XF3M-3015-1B	14.5	18.1	19.1	15.55	15.5	16.5	20.1
31	XF3M-3115-1B	15.0	18.6	19.6	16.05	16.0	17.0	20.6
(32)	XF3M-3215-1B	15.5	19.1	20.1	16.55	16.5	17.5	21.1
(33)	XF3M-3315-1B	16.0	19.6	20.6	17.05	17.0	18.0	21.6
(34)	XF3M-3415-1B	16.5	20.1	21.1	17.55	17.5	18.5	22.1
(35)	XF3M-3515-1B	17.0	20.6	21.6	18.05	18.0	19.0	22.6
(36)	XF3M-3615-1B	17.5	21.1	22.1	18.55	18.5	19.5	23.1
(38)	XF3M-3815-1B	18.5	22.1	23.1	19.55	19.5	20.5	24.1
40	XF3M-4015-1B	19.5	23.1	24.1	20.55	20.5	21.5	25.1
(41)	XF3M-4115-1B	20.0	23.6	24.6	21.05	21.0	22.0	25.6
(42)	XF3M-4215-1B	20.5	24.1	25.1	21.55	21.5	22.5	26.1
(45)	XF3M-4515-1B	22.0	25.6	26.6	23.05	23.0	24.0	27.6
50	XF3M-5015-1B	24.5	28.1	29.1	25.55	25.5	26.5	30.1
(55)	XF3M-5515-1B	27.0	30.6	31.6	28.05	28.0	29.0	32.6
60	XF3M-6015-1B	29.5	33.1	34.1	30.55	30.5	31.5	35.1

XF3M(1)-□□15-1B (1.0 mm pitch)

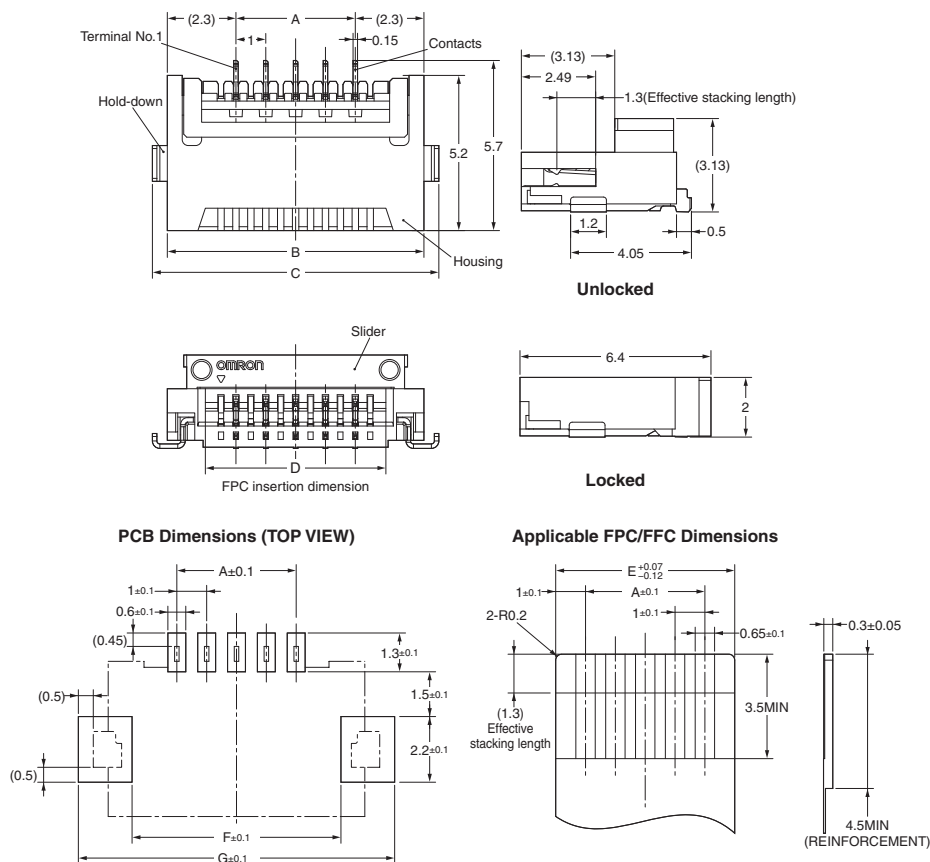

Table of Dimensions (1.0 mm pitch)

Pins	Model	A	B	C	D	E	F	G
4	XF3M(1)-0415-1B	3.0	7.6	8.6	5.05	5.0	6.0	9.6
5	XF3M(1)-0515-1B	4.0	8.6	9.6	6.05	6.0	7.0	10.6
(6)	XF3M(1)-0615-1B	5.0	9.6	10.6	7.05	7.0	8.0	11.6
(7)	XF3M(1)-0715-1B	6.0	10.6	11.6	8.05	8.0	9.0	12.6
(8)	XF3M(1)-0815-1B	7.0	11.6	12.6	9.05	9.0	10.0	13.6
(9)	XF3M(1)-0915-1B	8.0	12.6	13.6	10.05	10.0	11.0	14.6
(10)	XF3M(1)-1015-1B	9.0	13.6	14.6	11.05	11.0	12.0	15.6
12	XF3M(1)-1215-1B	11.0	15.6	16.6	13.05	13.0	14.0	17.6
15	XF3M(1)-1515-1B	14.0	18.6	19.6	16.05	16.0	17.0	20.6
(16)	XF3M(1)-1615-1B	15.0	19.6	20.6	17.05	17.0	18.0	21.6
(17)	XF3M(1)-1715-1B	16.0	20.6	21.6	18.05	18.0	19.0	22.6
18	XF3M(1)-1815-1B	17.0	21.6	22.6	19.05	19.0	20.0	23.6
(22)	XF3M(1)-2215-1B	21.0	25.6	26.6	23.05	23.0	24.0	27.6
30	XF3M(1)-3015-1B	29.0	33.6	34.6	31.05	31.0	32.0	35.6



All sales are subject to Omron Electronic Components LLC standard terms and conditions of sale, which can be found at http://www.components.omron.com/components/web/webfiles.nsf/sales_terms.html

ALL DIMENSIONS SHOWN ARE IN MILLIMETERS.

To convert millimeters into inches, multiply by 0.03937. To convert grams into ounces, multiply by 0.03527.

OMRON[®]

**OMRON ELECTRONIC
COMPONENTS LLC**

55 E. Commerce Drive, Suite B
Schaumburg, IL 60173

847-882-2288

OMRON ON-LINE

Global - <http://www.omron.com>

USA - <http://www.components.omron.com>

Cat. No. G011-E-18a

08/13

Specifications subject to change without notice

Printed in USA

Mouser Electronics

Authorized Distributor

Click to View Pricing, Inventory, Delivery & Lifecycle Information:

Omron:

[XF3M\(1\)-3015-1B](#) [XF3M-1015-1B](#) [XF3M-4015-1B](#) [XF3M-2015-1B](#) [XF3M-6015-1B](#) [XF3M-3015-1B](#) [XF3M\(1\)-1815-1B](#) [XF3M-1215-1B](#) [XF3M-5015-1B](#) [XF3M-1615-1B](#) [XF3M\(1\)-0415-1B](#) [XF3M-2515-1B](#) [XF3M\(1\)-0515-1B](#) [XF3M-2415-1B](#) [XF3M-3115-1B](#) [XF3M\(1\)-1215-1B](#) [XF3M\(1\)-1515-1B](#) [XF3M-0815-1B](#)