

### Features and Benefits

- Micropower consumption ideal for battery-powered applications
- Omnipolar, easy to use as output switches with both North and South pole
- Very High Sensitivity Hall Sensor
- Chopper stabilized amplifier stage
- Open-Drain Output
- Operation down to 1.5V
- Ultra-Thin QFN package (0.43mm max) & Thin SOT23 3L (both RoHS Compliant)

### Applications

- Solid State Switch
- Handheld Wireless Handset Awake Switch
- Lid close sensor for battery-powered devices
- Magnet proximity sensor for reed switch replacement in low duty cycle applications
- Energy metering

### Ordering Information

Product Code	Temperature Code	Package Code	Option Code	Packing Form Code
MLX90248	E	SE	EBA-000	RE
MLX90248	E	LD	EBA-000	RE

#### Legend:

Temperature Code: E for Temperature Range -40°C to 85°C  
 Package Code: SE for TSOT, LD for UTQFN  
 Packing Form: RE for Reel  
 Ordering example: MLX90248ESE-EBA-000-RE

### 1. Functional Diagram

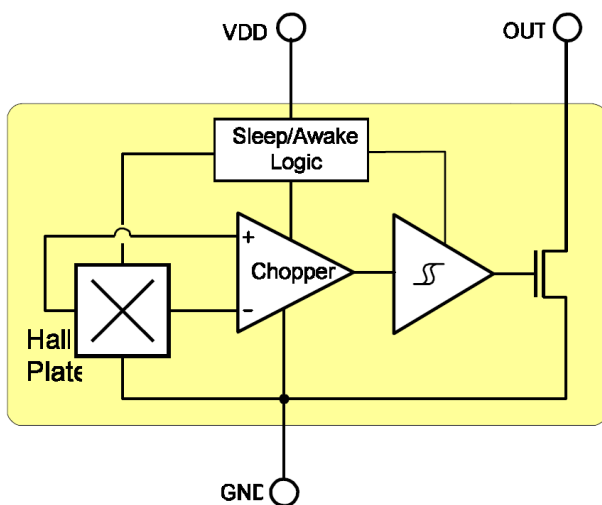

### 2. General Description

The MLX90248 Omnipolar Hall effect sensor technology. It incorporates advanced chopper-stabilization techniques to provide accurate and stable magnetic switch points.

The circuit design provides an internally controlled clocking mechanism to cycle power to the Hall element and analog signal processing circuits.

This serves to place the high current-consuming portions of the circuit into a “Sleep” mode. Periodically the device is “Awakened” by this internal logic and the magnetic flux from the Hall element is evaluated against the predefined thresholds. If the flux density is above or below the Bop/Brp thresholds then the output transistor is driven to change states accordingly. While in the “Sleep” cycle the output transistor is latched in its previous state. The design has been optimized for service in applications requiring extended operating lifetime in battery powered systems.

The output transistor of the 90248 will be latched on (BOP) in the presence of a sufficiently strong South or North magnetic field facing the marked side of the package. The output will be latched off (BRP) in the absence of a magnetic field.

## Contents

Features and Benefits.....	1
Applications.....	1
Ordering Information .....	1
1. Functional Diagram .....	1
2. General Description.....	1
3. Glossary of Terms.....	3
4. Absolute Maximum Ratings.....	3
5. Pin Definitions and Descriptions .....	3
6. Electrical Specifications .....	4
7. Magnetic Specifications.....	4
8. Outputs behavior vs. Magnetic Pole.....	4
9. Detailed General Description.....	5
10. Unique Features .....	5
11. Performance Graphs .....	6
11.1. Magnetic Thresholds vs. $T_A$ .....	6
11.2. Magnetic Thresholds vs. $V_{DD}$ .....	6
11.3. Current Consumption vs. $T_A$ .....	6
11.4. Current Consumption vs. $V_{DD}$ .....	6
11.5. Consumption Period vs. $T_A$ .....	6
11.6. Consumption Period vs. $V_{DD}$ .....	6
11.7. Output Saturation Voltage vs. $T_A$ .....	7
12. Application Information.....	7
13. Standard information regarding manufacturability of Melexis products with different soldering processes.....	7
14. ESD Precautions .....	8
15. Package Information .....	9
15.1. SE Package (TSOT-3L) .....	9
15.2. LD Package (UTQFN-6L).....	10
16. Contact.....	11
17. Disclaimer.....	11

### 3. Glossary of Terms

Gauss, milliTesla (mT),      Units of magnetic flux density :  
10 Gauss = 1mT

### 4. Absolute Maximum Ratings

Parameter	Symbol	Value	Units
Supply Voltage	$V_{DD}$	5	V
Supply Current	$I_{DD}$	5	mA
Output Voltage	$V_{OUT}$	5	V
Output Current	$I_{OUT}$	10	mA
Operating Temperature Range	$T_A$	-40 to 85	°C
Storage Temperature Range	$T_S$	-50 to 150	°C
ESD Sensitivity HBM <sup>(1)</sup>	-	8000	V
ESD Sensitivity MM <sup>(2)</sup>	-	800	V

Table 1: Absolute maximum ratings

**Note1:** Human Body Model (HBM) according AEC-Q100-002 Rev.D standard

**Note2:** Machine Model (MM) according AEC-Q100-003 Rev.E standard

Exceeding the absolute maximum ratings may cause permanent damage. Exposure to absolute-maximum-rated conditions for extended periods may affect device reliability.

### 5. Pin Definitions and Descriptions

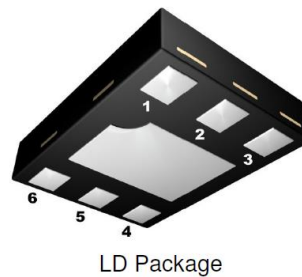
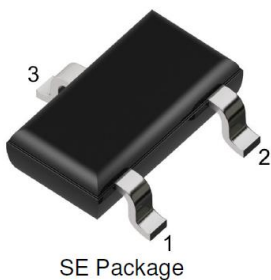

Pin Name	Function	Pin No (SE)	Pin No (LD)
VDD	Power Supply	1	2
GND	Ground	3	4
OUT	Output	2	5
N.C.	Not connected	-	1, 3, 6

Table 2: Pin definitions and descriptions

**Note:** Exposed Pad on LD package is connected to ground

## 6. Electrical Specifications

DC Operating Parameters  $T_A = 25^\circ\text{C}$ ,  $V_{DD} = 1.5\text{V to } 3.6\text{V}$  (unless otherwise specified)

Parameter	Symbol	Conditions	Min	Typ.	Max	Units
Supply Voltage	$V_{DD}$	Operating	1.5	-	3.6	V
Awake Supply Current	$I_{DD\text{awake}}$	$V_{DD} = 3.6\text{V}$	-	3	5	mA
Sleep Supply Current	$I_{DD\text{sleep}}$	$V_{DD} = 3.6\text{V}$	-	3.5	6	$\mu\text{A}$
Average Supply Current	$I_{DD\text{av}}$	$V_{DD} = 3.6\text{V}$ , Average	-	6.5	10	$\mu\text{A}$
Output Saturation Voltage	$V_{SAT}$	$I_{OUT} = 1\text{mA}$	-	0.27	0.4	V
Output Leakage Current	$I_{LEAK}$	$V_{DD} = 3.6\text{V}$	-	-	1	$\mu\text{A}$
Awake Period	$T_{AW}$	Operating	30	50	120	$\mu\text{s}$
Sleep Period	$T_{SL}$	Operating	25	40	70	ms

Table 3: Electrical specifications

## 7. Magnetic Specifications

DC Operating Parameters  $T_A = 25^\circ\text{C}$ ,  $V_{DD} = 1.5\text{V to } 3.6\text{V}$  (unless otherwise specified)

Parameter	Symbol	Min	Typ.	Max	Units
Operating Point	$B_{OP}$	+/-1.1	+/-3.8	+/-6	mT
Release Point	$B_{RP}$	+/-0.8	+/-2.8	+/-5.7	mT
Hysteresis	$B_{HYS}$	0.3	-	2.3	mT

Table 4: Magnetic specifications

**Note :** For typical values, please refer to the performance graphs section

## 8. Outputs behavior vs. Magnetic Pole

Parameter	Test conditions	OUT (SE)	OUT (LD)
North or South pole	$B >  B_{OP} $	Low	Low
“Zero” magnetic pole	$B <  B_{RP} $	High	High

Table 5: Outputs behavior vs. magnetic pole

**Note:** The magnetic pole is applied facing the branded side of the package

## 9. Detailed General Description

The MLX90248 is originally used in mobile phone applications for open/close lid detection (flip, slide and swivel phone type). The goal of this detection is to switch on or off the application if the lid is opened or closed, in order to save battery power.

The same operation principle can be simply applied to any other battery-powered device with a lid/cover like laptop, digital cameras and camcorders.

By the use of a very high sensitivity Hall sensor, a very small and cheap magnet is enough to trigger the MLX90248, hence it can easily replace reed switch.

The major benefit of using a Hall sensor is to provide “electronic” commutation, which is bounce-free, more reliable and with increased lifetime compared to usual mechanical contacts.

## 10. Unique Features

The MLX90248 exhibits “Omnipolar” magnetic characteristics. It means the device reacts to both North and South magnetic pole. The purpose is to detect the presence of any magnetic field applied on the device.

This mode of operation simplifies customer production processes by avoiding the need to detect the Hall sensor pole active on the magnet used in the application.

Taking the example of a generic Hall sensor “south pole active”, during its production, the customer must detect the south pole of the application magnet and face it to the device to enable the output to be turned on and off. Without any magnet pole detection system, the incorrect magnetic pole (north in this example) could be faced to the device which would fail the application.

Therefore, the “Omnipolar” magnetic behavior helps customers by removing the need of magnet pole detection system during production phase.

The “Micropower” feature makes the MLX90248 especially suitable for battery-powered device as it combines low voltage operation and low current consumption. By using a sleep/awake strategy managed internally, the power consumption is drastically reduced. To make a comparison, the MLX90248 consumes 100 times less power than the generic low voltage Melexis Hall sensor US3881.

As well as Thin SOT package, the MLX90248 is now delivered in a UTQFN package. This new leadless package only requires 3mm<sup>2</sup> PCB surface and is 0.43mm maximum thick, which is particularly important in design where space-saving and miniaturization are the critical factors.

## 11. Performance Graphs

Unless otherwise specified, performance graphs given at  $V_{DD} = 3.6V$  and  $T_A = 25\text{ }^\circ C$ .

### 11.1. Magnetic Thresholds vs. $T_A$

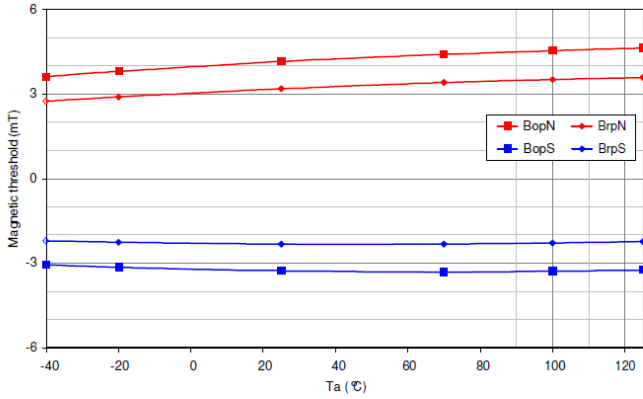

### 11.2. Magnetic Thresholds vs. $V_{DD}$

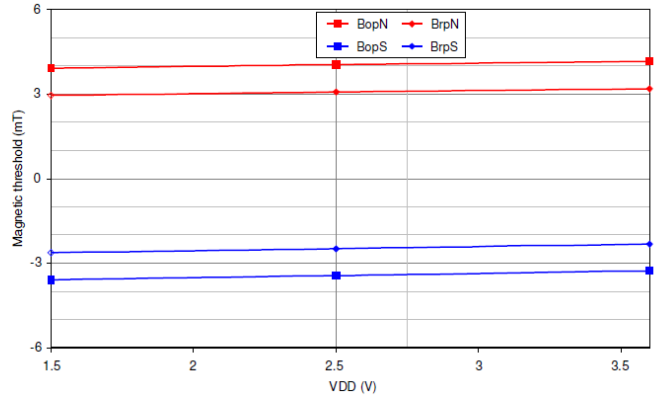

### 11.3. Current Consumption vs. $T_A$

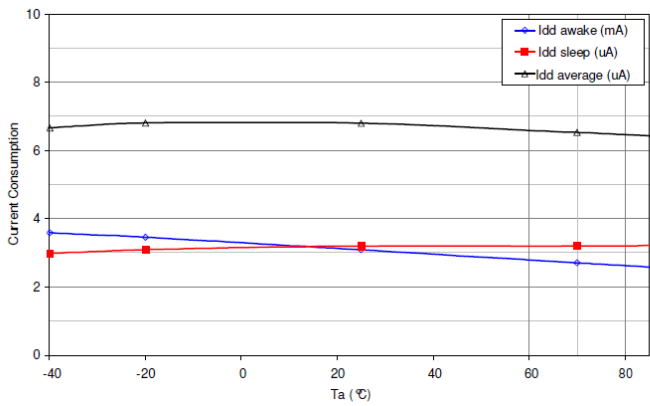

### 11.4. Current Consumption vs. $V_{DD}$

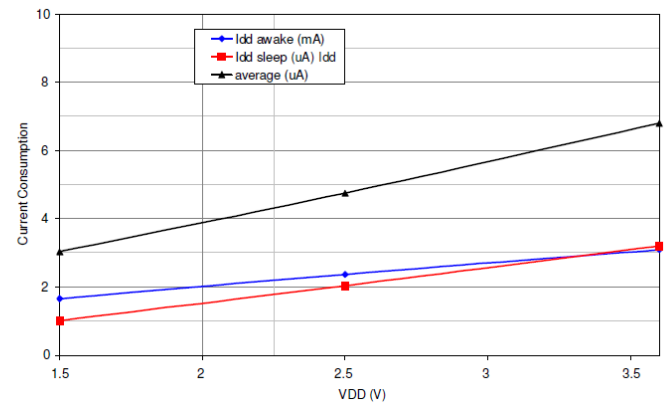

### 11.5. Consumption Period vs. $T_A$

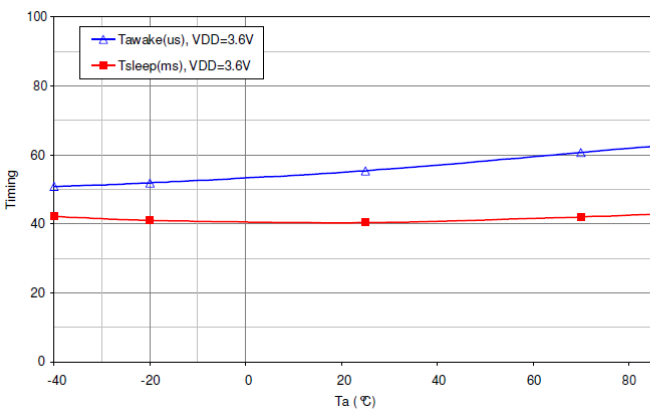

### 11.6. Consumption Period vs. $V_{DD}$

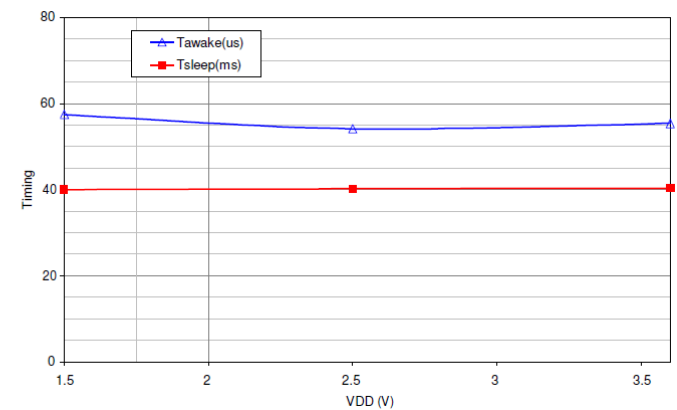

## 11.7. Output Saturation Voltage vs. $T_A$

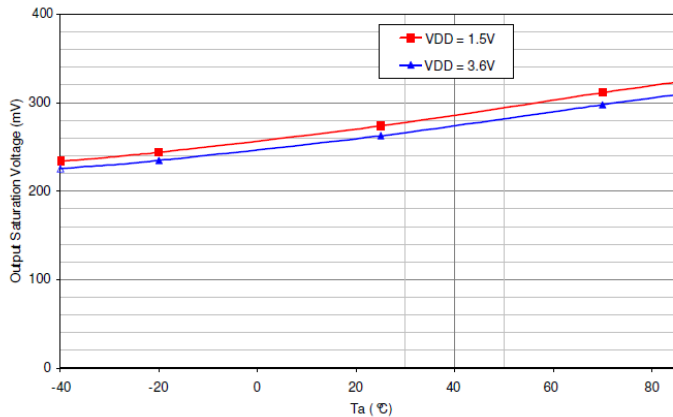

## 12. Application Information

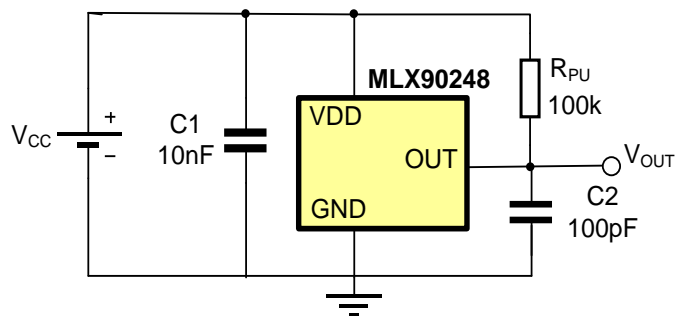

## 13. Standard information regarding manufacturability of Melexis products with different soldering processes

Our products are classified and qualified regarding soldering technology, solderability and moisture sensitivity level according to following test methods:

### Reflow Soldering SMD's (Surface Mount Devices)

- IPC/JEDEC J-STD-020  
Moisture/Reflow Sensitivity Classification for Nonhermetic Solid State Surface Mount Devices (classification reflow profiles according to table 5-2)
- EIA/JEDEC JESD22-A113  
Preconditioning of Nonhermetic Surface Mount Devices Prior to Reliability Testing (reflow profiles according to table 2)

### Wave Soldering SMD's (Surface Mount Devices) and THD's (Through Hole Devices)

- EN60749-20  
Resistance of plastic- encapsulated SMD's to combined effect of moisture and soldering heat
- EIA/JEDEC JESD22-B106 and EN60749-15  
Resistance to soldering temperature for through-hole mounted devices

**Iron Soldering THD's (Through Hole Devices)**

- EN60749-15  
Resistance to soldering temperature for through-hole mounted devices

**Solderability SMD's (Surface Mount Devices) and THD's (Through Hole Devices)**

- EIA/JEDEC JESD22-B102 and EN60749-21  
Solderability

For all soldering technologies deviating from above mentioned standard conditions (regarding peak temperature, temperature gradient, temperature profile etc) additional classification and qualification tests have to be agreed upon with Melexis.

The application of Wave Soldering for SMD's is allowed only after consulting Melexis regarding assurance of adhesive strength between device and board.

Melexis is contributing to global environmental conservation by promoting **lead free** solutions. For more information on qualifications of **RoHS** compliant products (RoHS = European directive on the Restriction Of the use of certain Hazardous Substances) please visit the quality page on our website: <http://www.melexis.com/quality.aspx>

## 14. ESD Precautions

Electronic semiconductor products are sensitive to Electro Static Discharge (ESD).

Always observe Electro Static Discharge control procedures whenever handling semiconductor products.



## 15. Package Information

### 15.1. SE Package (TSOT-3L)

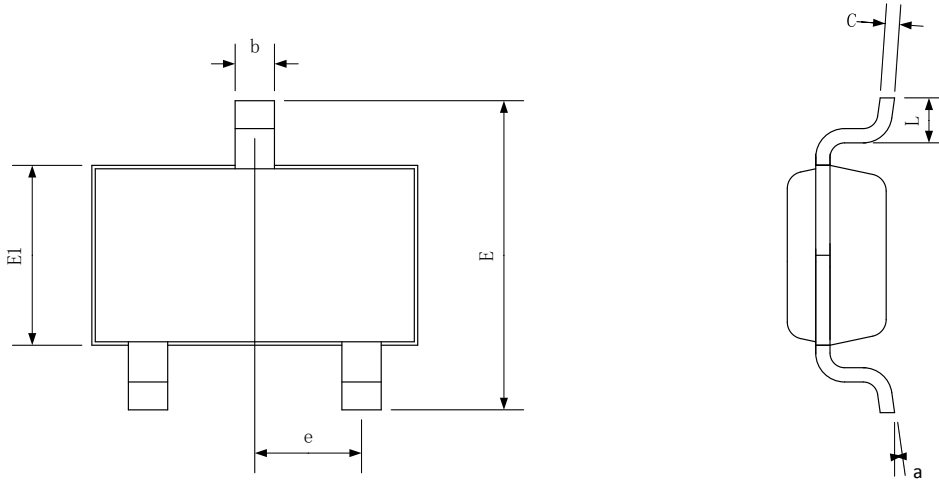

**Marking:**

Top side: 248E - Name of the Device (MLX90248)

Bottom side: xyww  
 x=last digit of lot number  
 y= last digit of year  
 ww = week

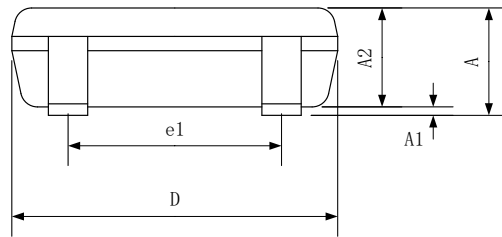

**Notes:**

1. Dimension "D" and "E1" do not include mold flash or protrusions. Mold flash or protrusion shall not exceed 0.15mm on "D" and 0.25mm on "E" per side.
2. Dimension "b" does not include dambar protrusion.

**Hall plate location**

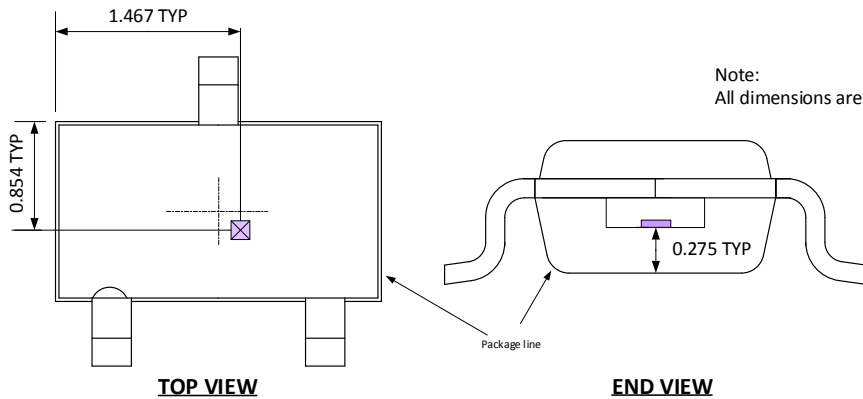

Note:  
All dimensions are in millimeters

This table in mm

	A	A1	A2	D	E	E1	L	b	c	e	e1	$\alpha$
min	-	0.025	0.85	2.80	2.60	1.50	0.30	0.30	0.10	BSC	BSC	0°
max	1.00	0.10	0.90	3.00	3.00	1.70	0.50	0.45	0.20			8°

## 15.2. LD Package (UTQFN-6L)

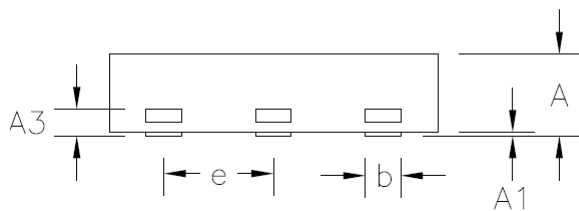
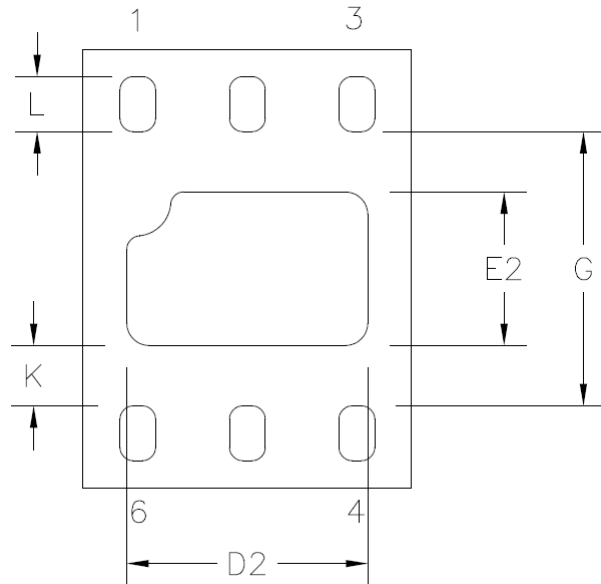
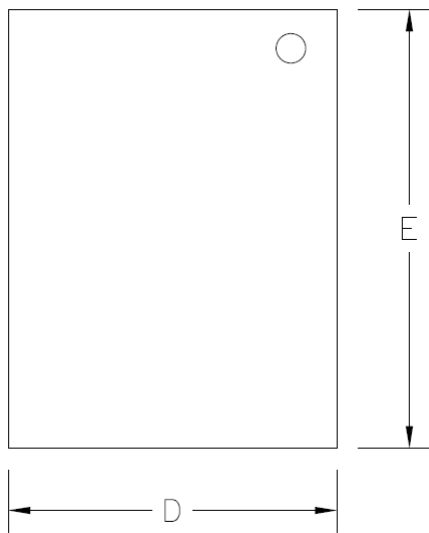

### Marking:

- 1<sup>st</sup> Line: .4E  
 ' ' (dot) used to show the 1<sup>st</sup> pin  
 4E: Name of the Device
- 2<sup>nd</sup> Line: YWW  
 Y- Year (last digit)  
 WW - Calendar Week

### Hall plate location

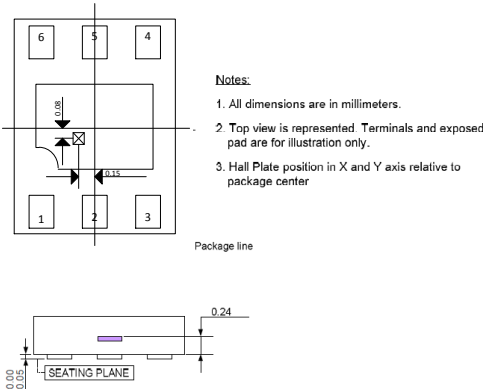

### Land Pattern

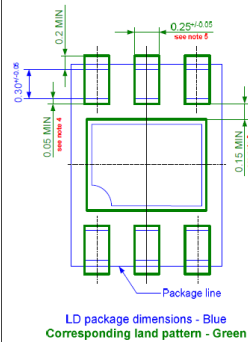

- Notes:**
- All dimensions are in millimeters.
  - Top view is represented. Package pads and outline are for reference.
  - Recommended minimal distance to prevent solder bridging.
  - Recommended distance for good solder filletting.
  - Due to lead pitch lower than 0.65mm, pad width should be limited to width of component terminal to reduce risk of solder bridging.
  - To enable thermal and electrical characteristics enhancement, the Exposed Pad must be connected to the PCB substrate with solder.
  - Exposed pad land pattern should be extended whenever possible. Therefore, its width is not limited whereas its height should respect the minimal distance as mentioned in note 3.
  - Land pattern based on package supplier's specification.

This table in mm

D x E	N	e		A	A1	A3	D2	E2	G	L	K	b
1.5 x 2	6	0.50	min	0.31	0.00	0.13	0.95	0.55	1.20	0.22	0.20	0.18
			max	0.40	0.05	REF	1.20	0.90	1.30	0.43	-	0.30

### Note:

- General tolerance of D and E is  $\pm 0.1\text{mm}$ .
- Bottom pin1 identification is may vary depends on the suppliers.

## 16. Contact

For the latest version of this document, go to our website at [www.melexis.com](http://www.melexis.com).

For additional information, please contact our Direct Sales team and get help for your specific needs:

Europe, Africa	Telephone: +32 13 67 04 95
	Email : sales_europe@melexis.com
Americas	Telephone: +1 603 223 2362
	Email : sales_usa@melexis.com
Asia	Email : sales_asia@melexis.com

## 17. Disclaimer

*The information furnished by Melexis herein ("Information") is believed to be correct and accurate. Melexis disclaims (i) any and all liability in connection with or arising out of the furnishing, performance or use of the technical data or use of the product(s) as described herein ("Product") (ii) any and all liability, including without limitation, special, consequential or incidental damages, and (iii) any and all warranties, express, statutory, implied, or by description, including warranties of fitness for particular purpose, non-infringement and merchantability. No obligation or liability shall arise or flow out of Melexis' rendering of technical or other services.*

*The Information is provided "as is" and Melexis reserves the right to change the Information at any time and without notice. Therefore, before placing orders and/or prior to designing the Product into a system, users or any third party should obtain the latest version of the relevant information to verify that the information being relied upon is current. Users or any third party must further determine the suitability of the Product for its application, including the level of reliability required and determine whether it is fit for a particular purpose.*

*The Information is proprietary and/or confidential information of Melexis and the use thereof or anything described by the Information does not grant, explicitly or implicitly, to any party any patent rights, licenses, or any other intellectual property rights.*

*This document as well as the Product(s) may be subject to export control regulations. Please be aware that export might require a prior authorization from competent authorities.*

*The Product(s) are intended for use in normal commercial applications. Unless otherwise agreed upon in writing, the Product(s) are not designed, authorized or warranted to be suitable in applications requiring extended temperature range and/or unusual environmental requirements. High reliability applications, such as medical life-support or life-sustaining equipment are specifically not recommended by Melexis.*

*The Product(s) may not be used for the following applications subject to export control regulations: the development, production, processing, operation, maintenance, storage, recognition or proliferation of 1) chemical, biological or nuclear weapons, or for the development, production, maintenance or storage of missiles for such weapons; 2) civil firearms, including spare parts or ammunition for such arms; 3) defense related products, or other material for military use or for law enforcement; 4) any applications that, alone or in combination with other goods, substances or organisms could cause serious harm to persons or goods and that can be used as a means of violence in an armed conflict or any similar violent situation.*

*The Products sold by Melexis are subject to the terms and conditions as specified in the Terms of Sale, which can be found at <https://www.melexis.com/en/legal/terms-and-conditions>.*

*This document supersedes and replaces all prior information regarding the Product(s) and/or previous versions of this document.*

*Melexis NV © - No part of this document may be reproduced without the prior written consent of Melexis. (2016)*

*ISO/TS 16949 and ISO14001 Certified*

# Mouser Electronics

Authorized Distributor

Click to View Pricing, Inventory, Delivery & Lifecycle Information:

[Melexis:](#)

[MLX90248ELD-EBA-000-RE](#) [MLX90248ESE-EBA-000-RE](#) [MLX90248ESE-EBA-000-SP](#) [MLX90248ELD-EBA-000-SP](#)