

Click to view price, real time Inventory,  
Delivery & Lifecycle Information ;

# F3L400R07W3S5\_B59

## Infineon Technologies

IGBT Modules LOW POWER EASY

Any questions, please feel free to contact us.  
[info@kaimte.com](mailto:info@kaimte.com)

## EasyPACK™ module with TRENCHSTOP™ 5 and Emitter Controlled 3 diode and PressFIT / NTC

### Features

- Electrical features
  - $V_{CES} = 650\text{ V}$
  - $I_{C\text{nom}} = 200\text{ A} / I_{CRM} = 400\text{ A}$
  - Low switching losses
- Mechanical features
  - $\text{Al}_2\text{O}_3$  substrate with low thermal resistance
  - Compact design
  - PressFIT contact technology
  - Integrated NTC temperature sensor
  - High power density



### Potential applications

- Solar applications
- 3-level-applications

### Product validation

- Qualified for industrial applications according to the relevant tests of IEC 60747, 60749 and 60068

### Description

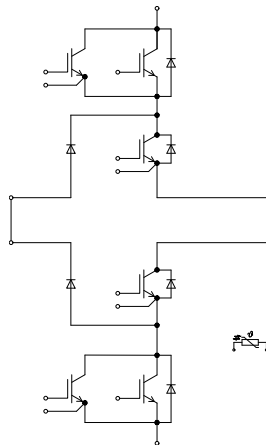

## Table of contents

	<b>Description</b> .....	1
	<b>Features</b> .....	1
	<b>Potential applications</b> .....	1
	<b>Product validation</b> .....	1
	<b>Table of contents</b> .....	2
<b>1</b>	<b>Package</b> .....	3
<b>2</b>	<b>IGBT, T1.1 / T1.2 / T4.1 / T4.2</b> .....	3
<b>3</b>	<b>IGBT, T2 / T3</b> .....	5
<b>4</b>	<b>Diode, D1 / D4</b> .....	6
<b>5</b>	<b>Diode, D2 / D3</b> .....	7
<b>6</b>	<b>Diode, D5 / D6</b> .....	8
<b>7</b>	<b>NTC-Thermistor</b> .....	9
<b>8</b>	<b>Characteristics diagrams</b> .....	10
<b>9</b>	<b>Circuit diagram</b> .....	19
<b>10</b>	<b>Package outlines</b> .....	20
<b>11</b>	<b>Module label code</b> .....	20
	<b>Revision history</b> .....	21
	<b>Disclaimer</b> .....	22

## 1 Package

**Table 1** Insulation coordination

Parameter	Symbol	Note or test condition	Values	Unit
Isolation test voltage	$V_{ISOL}$	RMS, $f = 50 \text{ Hz}$ , $t = 1 \text{ min}$	3.2	kV
Internal Isolation		basic insulation (class 1, IEC 61140)	$\text{Al}_2\text{O}_3$	
Creepage distance	$d_{Creep}$	terminal to heatsink	11.2	mm
Creepage distance	$d_{Creep}$	terminal to terminal	6.8	mm
Clearance	$d_{Clear}$	terminal to heatsink	9.4	mm
Clearance	$d_{Clear}$	terminal to terminal	5.5	mm
Comparative tracking index	$CTI$		> 400	
RTI Elec.	$RTI$	housing	140	°C

**Table 2** Characteristic values

Parameter	Symbol	Note or test condition	Values			Unit
			Min.	Typ.	Max.	
Stray inductance module	$L_{SCE}$			12		nH
Storage temperature	$T_{stg}$		-40		125	°C
Mounting torque for modul mounting	$M$	- Mounting according to valid application note	M5, Screw	1.3	1.5	Nm
Weight	$G$			78		g

Note: The current under continuous operation is limited to 25A rms per connector pin.

## 2 IGBT, T1.1 / T1.2 / T4.1 / T4.2

**Table 3** Maximum rated values

Parameter	Symbol	Note or test condition	Values	Unit
Collector-emitter voltage	$V_{CES}$	$T_{vj} = 25 \text{ °C}$	650	V
Implemented collector current	$I_{CN}$		200	A
Continuous DC collector current	$I_{CDC}$	$T_{vj \text{ max}} = 175 \text{ °C}$ $T_H = 65 \text{ °C}$	130	A
Repetitive peak collector current	$I_{CRM}$	$t_p = 1 \text{ ms}$	400	A
Gate-emitter peak voltage	$V_{GES}$		±20	V

**Table 4** Characteristic values

Parameter	Symbol	Note or test condition	Values			Unit
			Min.	Typ.	Max.	
Collector-emitter saturation voltage	$V_{CE\ sat}$	$I_C = 100\ A, V_{GE} = 15\ V$	$T_{vj} = 25\ ^\circ C$	1.17	1.50	V
			$T_{vj} = 125\ ^\circ C$	1.20		
			$T_{vj} = 150\ ^\circ C$	1.21		
Gate threshold voltage	$V_{GEth}$	$I_C = 2\ mA, V_{CE} = V_{GE}, T_{vj} = 25\ ^\circ C$	3.25	4	4.75	V
Gate charge	$Q_G$	$V_{GE} = \pm 15\ V, V_{CE} = 400\ V$		0.84		$\mu C$
Internal gate resistor	$R_{Gint}$	$T_{vj} = 25\ ^\circ C$		0		$\Omega$
Input capacitance	$C_{ies}$	$f = 100\ kHz, T_{vj} = 25\ ^\circ C, V_{CE} = 25\ V, V_{GE} = 0\ V$		14.3		nF
Reverse transfer capacitance	$C_{res}$	$f = 100\ kHz, T_{vj} = 25\ ^\circ C, V_{CE} = 25\ V, V_{GE} = 0\ V$		0.05		nF
Collector-emitter cut-off current	$I_{CES}$	$V_{CE} = 650\ V, V_{GE} = 0\ V$	$T_{vj} = 25\ ^\circ C$		0.019	mA
Gate-emitter leakage current	$I_{GES}$	$V_{CE} = 0\ V, V_{GE} = 20\ V, T_{vj} = 25\ ^\circ C$			100	nA
Turn-on delay time (inductive load)	$t_{don}$	$I_C = 100\ A, V_{CE} = 300\ V, V_{GE} = \pm 15\ V, R_{Gon} = 4.7\ \Omega$	$T_{vj} = 25\ ^\circ C$	0.022		$\mu s$
			$T_{vj} = 125\ ^\circ C$	0.021		
			$T_{vj} = 150\ ^\circ C$	0.021		
Rise time (inductive load)	$t_r$	$I_C = 100\ A, V_{CE} = 300\ V, V_{GE} = \pm 15\ V, R_{Gon} = 4.7\ \Omega$	$T_{vj} = 25\ ^\circ C$	0.013		$\mu s$
			$T_{vj} = 125\ ^\circ C$	0.015		
			$T_{vj} = 150\ ^\circ C$	0.015		
Turn-off delay time (inductive load)	$t_{doff}$	$I_C = 100\ A, V_{CE} = 300\ V, V_{GE} = \pm 15\ V, R_{Goff} = 4.7\ \Omega$	$T_{vj} = 25\ ^\circ C$	0.117		$\mu s$
			$T_{vj} = 125\ ^\circ C$	0.145		
			$T_{vj} = 150\ ^\circ C$	0.158		
Fall time (inductive load)	$t_f$	$I_C = 100\ A, V_{CE} = 300\ V, V_{GE} = \pm 15\ V, R_{Goff} = 4.7\ \Omega$	$T_{vj} = 25\ ^\circ C$	0.044		$\mu s$
			$T_{vj} = 125\ ^\circ C$	0.046		
			$T_{vj} = 150\ ^\circ C$	0.047		
Turn-on energy loss per pulse	$E_{on}$	$I_C = 100\ A, V_{CE} = 300\ V, L_\sigma = 35\ nH, V_{GE} = \pm 15\ V, R_{Gon} = 4.7\ \Omega, di/dt = 12.5\ kA/\mu s (T_{vj} = 150\ ^\circ C)$	$T_{vj} = 25\ ^\circ C$	1		mJ
			$T_{vj} = 125\ ^\circ C$	1.4		
			$T_{vj} = 150\ ^\circ C$	1.49		
Turn-off energy loss per pulse	$E_{off}$	$I_C = 100\ A, V_{CE} = 300\ V, L_\sigma = 35\ nH, V_{GE} = \pm 15\ V, R_{Goff} = 4.7\ \Omega, dv/dt = 4400\ V/\mu s (T_{vj} = 150\ ^\circ C)$	$T_{vj} = 25\ ^\circ C$	0.78		mJ
			$T_{vj} = 125\ ^\circ C$	1.28		
			$T_{vj} = 150\ ^\circ C$	1.4		
Thermal resistance, junction to heatsink	$R_{thJH}$	per IGBT, $\lambda_{grease} = 3.3\ W/(m^*K)$		0.478		K/W
Temperature under switching conditions	$T_{vj\ op}$		-40		150	$^\circ C$

### 3 IGBT, T2 / T3

**Table 5** Maximum rated values

Parameter	Symbol	Note or test condition		Values			Unit
				Min.	Typ.	Max.	
Collector-emitter voltage	$V_{CES}$		$T_{vj} = 25\text{ °C}$		650		V
Implemented collector current	$I_{CN}$				300		A
Continuous DC collector current	$I_{CDC}$	$T_{vj\ max} = 175\text{ °C}$	$T_H = 65\text{ °C}$		255		A
Repetitive peak collector current	$I_{CRM}$	$t_p = 1\text{ ms}$			600		A
Gate-emitter peak voltage	$V_{GES}$				±20		V

**Table 6** Characteristic values

Parameter	Symbol	Note or test condition		Values			Unit
				Min.	Typ.	Max.	
Collector-emitter saturation voltage	$V_{CE\ sat}$	$I_C = 100\text{ A}, V_{GE} = 15\text{ V}$	$T_{vj} = 25\text{ °C}$		0.88	1.13	V
			$T_{vj} = 125\text{ °C}$		0.80		
			$T_{vj} = 150\text{ °C}$		0.77		
Gate threshold voltage	$V_{Geth}$	$I_C = 4\text{ mA}, V_{CE} = 20\text{ V}, T_{vj} = 25\text{ °C}$		4.25	5	5.75	V
Gate charge	$Q_G$	$V_{GE} = \pm 15\text{ V}, V_{CE} = 400\text{ V}$			3.7		μC
Internal gate resistor	$R_{Gint}$	$T_{vj} = 25\text{ °C}$			0		Ω
Input capacitance	$C_{ies}$	$f = 100\text{ kHz}, T_{vj} = 25\text{ °C}, V_{CE} = 25\text{ V}, V_{GE} = 0\text{ V}$			47.1		nF
Reverse transfer capacitance	$C_{res}$	$f = 100\text{ kHz}, T_{vj} = 25\text{ °C}, V_{CE} = 25\text{ V}, V_{GE} = 0\text{ V}$			0.168		nF
Collector-emitter cut-off current	$I_{CES}$	$V_{CE} = 650\text{ V}, V_{GE} = 0\text{ V}$	$T_{vj} = 25\text{ °C}$			0.019	mA
Gate-emitter leakage current	$I_{GES}$	$V_{CE} = 0\text{ V}, V_{GE} = 20\text{ V}, T_{vj} = 25\text{ °C}$				100	nA
Turn-on delay time (inductive load)	$t_{don}$	$I_C = 100\text{ A}, V_{CE} = 300\text{ V}, V_{GE} = \pm 15\text{ V}, R_{Gon} = 6.8\text{ }\Omega$	$T_{vj} = 25\text{ °C}$		0.128		μs
			$T_{vj} = 125\text{ °C}$		0.108		
			$T_{vj} = 150\text{ °C}$		0.103		
Rise time (inductive load)	$t_r$	$I_C = 100\text{ A}, V_{CE} = 300\text{ V}, V_{GE} = \pm 15\text{ V}, R_{Gon} = 6.8\text{ }\Omega$	$T_{vj} = 25\text{ °C}$		0.025		μs
			$T_{vj} = 125\text{ °C}$		0.030		
			$T_{vj} = 150\text{ °C}$		0.031		
Turn-off delay time (inductive load)	$t_{doff}$	$I_C = 100\text{ A}, V_{CE} = 300\text{ V}, V_{GE} = \pm 15\text{ V}, R_{Goff} = 6.8\text{ }\Omega$	$T_{vj} = 25\text{ °C}$		0.693		μs
			$T_{vj} = 125\text{ °C}$		0.821		
			$T_{vj} = 150\text{ °C}$		0.853		

**Table 6** Characteristic values (continued)

Parameter	Symbol	Note or test condition	Values			Unit
			Min.	Typ.	Max.	
Fall time (inductive load)	$t_f$	$I_C = 100\text{ A}$ , $V_{CE} = 300\text{ V}$ , $V_{GE} = \pm 15\text{ V}$ , $R_{Goff} = 6.8\ \Omega$	$T_{vj} = 25\text{ }^\circ\text{C}$	0.129		$\mu\text{s}$
			$T_{vj} = 125\text{ }^\circ\text{C}$	0.213		
			$T_{vj} = 150\text{ }^\circ\text{C}$	0.234		
Turn-on energy loss per pulse	$E_{on}$	$I_C = 100\text{ A}$ , $V_{CE} = 300\text{ V}$ , $L_\sigma = 35\text{ nH}$ , $V_{GE} = \pm 15\text{ V}$ , $R_{Gon} = 6.8\ \Omega$ , $di/dt =$ $2700\text{ A}/\mu\text{s}$ ( $T_{vj} = 150\text{ }^\circ\text{C}$ )	$T_{vj} = 25\text{ }^\circ\text{C}$	1.06		mJ
			$T_{vj} = 125\text{ }^\circ\text{C}$	1.44		
			$T_{vj} = 150\text{ }^\circ\text{C}$	1.54		
Turn-off energy loss per pulse	$E_{off}$	$I_C = 100\text{ A}$ , $V_{CE} = 300\text{ V}$ , $L_\sigma = 35\text{ nH}$ , $V_{GE} = \pm 15\text{ V}$ , $R_{Goff} = 6.8\ \Omega$ , $dv/dt = 760$ $\text{V}/\mu\text{s}$ ( $T_{vj} = 150\text{ }^\circ\text{C}$ )	$T_{vj} = 25\text{ }^\circ\text{C}$	5.24		mJ
			$T_{vj} = 125\text{ }^\circ\text{C}$	8.18		
			$T_{vj} = 150\text{ }^\circ\text{C}$	8.84		
Thermal resistance, junction to heatsink	$R_{thJH}$	per IGBT, $\lambda_{grease} = 3.3\text{ W}/(\text{m}^*\text{K})$		0.300		K/W
Temperature under switching conditions	$T_{vj\text{ op}}$		-40		150	$^\circ\text{C}$

## 4 Diode, D1 / D4

**Table 7** Maximum rated values

Parameter	Symbol	Note or test condition	Values	Unit	
Repetitive peak reverse voltage	$V_{RRM}$	$T_{vj} = 25\text{ }^\circ\text{C}$	650	V	
Implemented forward current	$I_{FN}$		225	A	
Continuous DC forward current	$I_F$		100	A	
Repetitive peak forward current	$I_{FRM}$	$t_p = 1\text{ ms}$	450	A	
$I^2t$ - value	$I^2t$	$V_R = 0\text{ V}$ , $t_p = 10\text{ ms}$	$T_{vj} = 125\text{ }^\circ\text{C}$	3030	$\text{A}^2\text{s}$
			$T_{vj} = 150\text{ }^\circ\text{C}$	2760	

**Table 8** Characteristic values

Parameter	Symbol	Note or test condition	Values			Unit
			Min.	Typ.	Max.	
Forward voltage	$V_F$	$I_F = 100\text{ A}$ , $V_{GE} = 0\text{ V}$	$T_{vj} = 25\text{ }^\circ\text{C}$	1.26	1.55	V
			$T_{vj} = 125\text{ }^\circ\text{C}$	1.16		
			$T_{vj} = 150\text{ }^\circ\text{C}$	1.11		

**Table 8** Characteristic values (continued)

Parameter	Symbol	Note or test condition	Values			Unit
			Min.	Typ.	Max.	
Peak reverse recovery current	$I_{RM}$	$I_F = 100\text{ A}$ , $V_R = 300\text{ V}$ , $V_{GE} = -15\text{ V}$ , $-di_F/dt = 2700\text{ A}/\mu\text{s}$ ( $T_{vj} = 150\text{ °C}$ )	$T_{vj} = 25\text{ °C}$	105		A
			$T_{vj} = 125\text{ °C}$	141		
			$T_{vj} = 150\text{ °C}$	151		
Recovered charge	$Q_r$	$I_F = 100\text{ A}$ , $V_R = 300\text{ V}$ , $V_{GE} = -15\text{ V}$ , $-di_F/dt = 2700\text{ A}/\mu\text{s}$ ( $T_{vj} = 150\text{ °C}$ )	$T_{vj} = 25\text{ °C}$	5.94		$\mu\text{C}$
			$T_{vj} = 125\text{ °C}$	11.6		
			$T_{vj} = 150\text{ °C}$	13.5		
Reverse recovery energy	$E_{rec}$	$I_F = 100\text{ A}$ , $V_R = 300\text{ V}$ , $V_{GE} = -15\text{ V}$ , $-di_F/dt = 2700\text{ A}/\mu\text{s}$ ( $T_{vj} = 150\text{ °C}$ )	$T_{vj} = 25\text{ °C}$	1.3		mJ
			$T_{vj} = 125\text{ °C}$	2.58		
			$T_{vj} = 150\text{ °C}$	3.01		
Thermal resistance, junction to heatsink	$R_{thJH}$	per diode, $\lambda_{grease} = 3.3\text{ W}/(\text{m}^2\text{K})$		0.431		K/W
Temperature under switching conditions	$T_{vj\text{ op}}$		-40		150	$^{\circ}\text{C}$

## 5 Diode, D2 / D3

**Table 9** Maximum rated values

Parameter	Symbol	Note or test condition	Values	Unit	
Repetitive peak reverse voltage	$V_{RRM}$	$T_{vj} = 25\text{ °C}$	650	V	
Implemented forward current	$I_{FN}$		225	A	
Continuous DC forward current	$I_F$		100	A	
Repetitive peak forward current	$I_{FRM}$	$t_p = 1\text{ ms}$	450	A	
$I^2t$ - value	$I^2t$	$V_R = 0\text{ V}$ , $t_p = 10\text{ ms}$	$T_{vj} = 125\text{ °C}$	3030	$\text{A}^2\text{s}$
			$T_{vj} = 150\text{ °C}$	2760	

**Table 10** Characteristic values

Parameter	Symbol	Note or test condition	Values			Unit
			Min.	Typ.	Max.	
Forward voltage	$V_F$	$I_F = 100\text{ A}$ , $V_{GE} = 0\text{ V}$	$T_{vj} = 25\text{ °C}$	1.26	1.55	V
			$T_{vj} = 125\text{ °C}$	1.16		
			$T_{vj} = 150\text{ °C}$	1.11		



**Table 10** Characteristic values (continued)

Parameter	Symbol	Note or test condition	Values			Unit
			Min.	Typ.	Max.	
Peak reverse recovery current	$I_{RM}$	$I_F = 100\text{ A}$ , $V_R = 300\text{ V}$ , $V_{GE} = -15\text{ V}$ , $-di_F/dt = 2700\text{ A}/\mu\text{s}$ ( $T_{vj} = 150\text{ °C}$ )	$T_{vj} = 25\text{ °C}$	105		A
			$T_{vj} = 125\text{ °C}$	141		
			$T_{vj} = 150\text{ °C}$	151		
Recovered charge	$Q_r$	$I_F = 100\text{ A}$ , $V_R = 300\text{ V}$ , $V_{GE} = -15\text{ V}$ , $-di_F/dt = 2700\text{ A}/\mu\text{s}$ ( $T_{vj} = 150\text{ °C}$ )	$T_{vj} = 25\text{ °C}$	5.94		$\mu\text{C}$
			$T_{vj} = 125\text{ °C}$	11.6		
			$T_{vj} = 150\text{ °C}$	13.5		
Reverse recovery energy	$E_{rec}$	$I_F = 100\text{ A}$ , $V_R = 300\text{ V}$ , $V_{GE} = -15\text{ V}$ , $-di_F/dt = 2700\text{ A}/\mu\text{s}$ ( $T_{vj} = 150\text{ °C}$ )	$T_{vj} = 25\text{ °C}$	1.3		mJ
			$T_{vj} = 125\text{ °C}$	2.58		
			$T_{vj} = 150\text{ °C}$	3.01		
Thermal resistance, junction to heatsink	$R_{thJH}$	per diode, $\lambda_{grease} = 3.3\text{ W}/(\text{m}^2\text{K})$		0.390		K/W
Temperature under switching conditions	$T_{vj\text{ op}}$		-40		150	$^{\circ}\text{C}$

## 6 Diode, D5 / D6

**Table 11** Maximum rated values

Parameter	Symbol	Note or test condition	Values	Unit	
Repetitive peak reverse voltage	$V_{RRM}$	$T_{vj} = 25\text{ °C}$	650	V	
Implemented forward current	$I_{FN}$		300	A	
Continuous DC forward current	$I_F$		100	A	
Repetitive peak forward current	$I_{FRM}$	$t_p = 1\text{ ms}$	600	A	
$I^2t$ - value	$I^2t$	$V_R = 0\text{ V}$ , $t_p = 10\text{ ms}$	$T_{vj} = 125\text{ °C}$	6610	$\text{A}^2\text{s}$
			$T_{vj} = 150\text{ °C}$	6050	

**Table 12** Characteristic values

Parameter	Symbol	Note or test condition	Values			Unit
			Min.	Typ.	Max.	
Forward voltage	$V_F$	$I_F = 100\text{ A}$ , $V_{GE} = 0\text{ V}$	$T_{vj} = 25\text{ °C}$	1.19	1.47	V
			$T_{vj} = 125\text{ °C}$	1.07		
			$T_{vj} = 150\text{ °C}$	1.02		

**Table 12** Characteristic values (continued)

Parameter	Symbol	Note or test condition	Values			Unit
			Min.	Typ.	Max.	
Peak reverse recovery current	$I_{RM}$	$I_F = 100\text{ A}$ , $V_R = 300\text{ V}$ , $V_{GE} = -15\text{ V}$ , $-di_F/dt = 12.5\text{ kA}/\mu\text{s}$ ( $T_{vj} = 150\text{ }^\circ\text{C}$ )	$T_{vj} = 25\text{ }^\circ\text{C}$	135		A
			$T_{vj} = 125\text{ }^\circ\text{C}$	186		
			$T_{vj} = 150\text{ }^\circ\text{C}$	199		
Recovered charge	$Q_r$	$I_F = 100\text{ A}$ , $V_R = 300\text{ V}$ , $V_{GE} = -15\text{ V}$ , $-di_F/dt = 12.5\text{ kA}/\mu\text{s}$ ( $T_{vj} = 150\text{ }^\circ\text{C}$ )	$T_{vj} = 25\text{ }^\circ\text{C}$	5.05		$\mu\text{C}$
			$T_{vj} = 125\text{ }^\circ\text{C}$	12		
			$T_{vj} = 150\text{ }^\circ\text{C}$	14.4		
Reverse recovery energy	$E_{rec}$	$I_F = 100\text{ A}$ , $V_R = 300\text{ V}$ , $V_{GE} = -15\text{ V}$ , $-di_F/dt = 12.5\text{ kA}/\mu\text{s}$ ( $T_{vj} = 150\text{ }^\circ\text{C}$ )	$T_{vj} = 25\text{ }^\circ\text{C}$	0.931		mJ
			$T_{vj} = 125\text{ }^\circ\text{C}$	2.64		
			$T_{vj} = 150\text{ }^\circ\text{C}$	3.26		
Thermal resistance, junction to heatsink	$R_{thJH}$	per diode, $\lambda_{grease} = 3.3\text{ W}/(\text{m}^2\text{K})$		0.479		K/W
Temperature under switching conditions	$T_{vj\text{ op}}$		-40		150	$^\circ\text{C}$

## 7 NTC-Thermistor

**Table 13** Characteristic values

Parameter	Symbol	Note or test condition	Values			Unit
			Min.	Typ.	Max.	
Rated resistance	$R_{25}$	$T_{NTC} = 25\text{ }^\circ\text{C}$		5		k $\Omega$
Deviation of $R_{100}$	$\Delta R/R$	$T_{NTC} = 100\text{ }^\circ\text{C}$ , $R_{100} = 493\text{ }\Omega$	-5		5	%
Power dissipation	$P_{25}$	$T_{NTC} = 25\text{ }^\circ\text{C}$			20	mW
B-value	$B_{25/50}$	$R_2 = R_{25} \exp[B_{25/50}(1/T_2 - 1/(298,15\text{ K}))]$		3375		K
B-value	$B_{25/80}$	$R_2 = R_{25} \exp[B_{25/80}(1/T_2 - 1/(298,15\text{ K}))]$		3411		K
B-value	$B_{25/100}$	$R_2 = R_{25} \exp[B_{25/100}(1/T_2 - 1/(298,15\text{ K}))]$		3433		K

Note: Specification according to the valid application note.

## 8 Characteristics diagrams

**output characteristic (typical), IGBT, T1.1 / T1.2 / T4.1 / T4.2**

$I_C = f(V_{CE})$   
 $V_{GE} = 15\text{ V}$

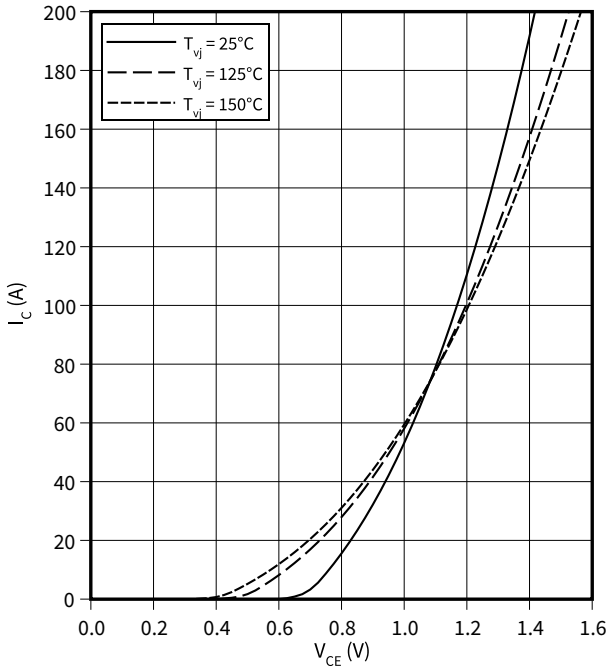

**output characteristic (typical), IGBT, T1.1 / T1.2 / T4.1 / T4.2**

$I_C = f(V_{CE})$   
 $T_{vj} = 150\text{ °C}$

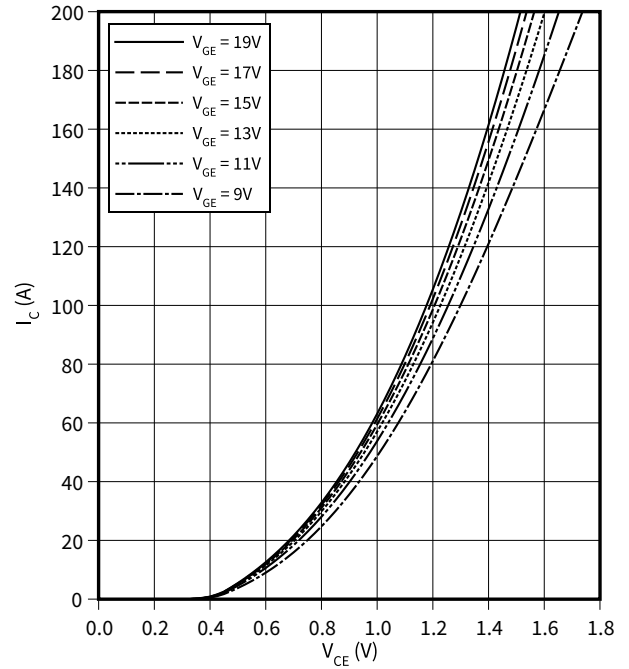

**transfer characteristic (typical), IGBT, T1.1 / T1.2 / T4.1 / T4.2**

$I_C = f(V_{GE})$   
 $V_{CE} = 20\text{ V}$

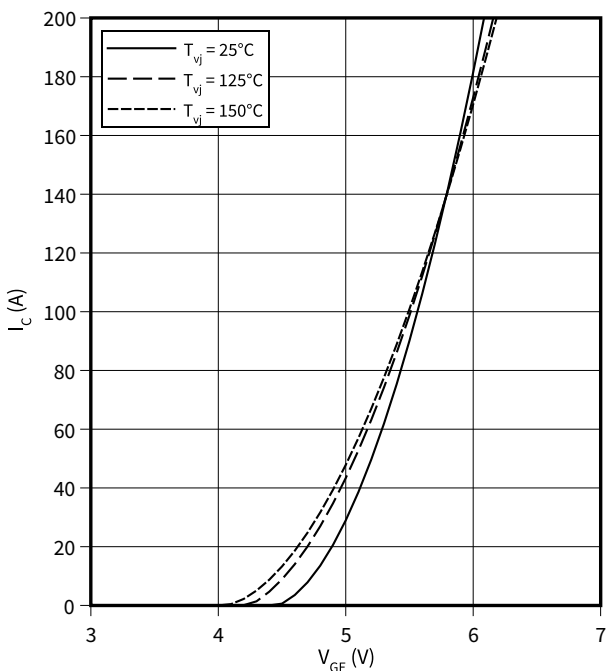

**switching losses (typical), IGBT, T1.1 / T1.2 / T4.1 / T4.2**

$E = f(I_C)$   
 $R_{Goff} = 4.7\ \Omega, R_{Gon} = 4.7\ \Omega, V_{CE} = 300\text{ V}, V_{GE} = \pm 15\text{ V}$

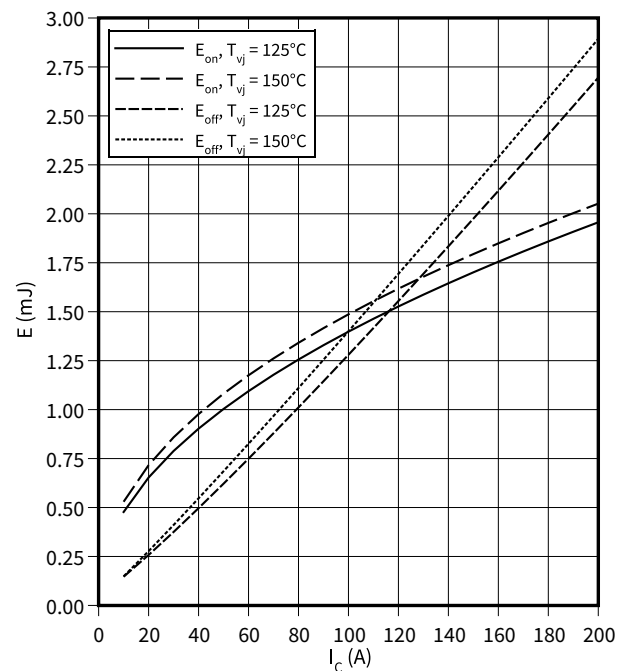

8 Characteristics diagrams

**switching losses (typical), IGBT, T1.1 / T1.2 / T4.1 / T4.2**

$E = f(R_G)$

$I_C = 100 \text{ A}, V_{CE} = 300 \text{ V}, V_{GE} = \pm 15 \text{ V}$

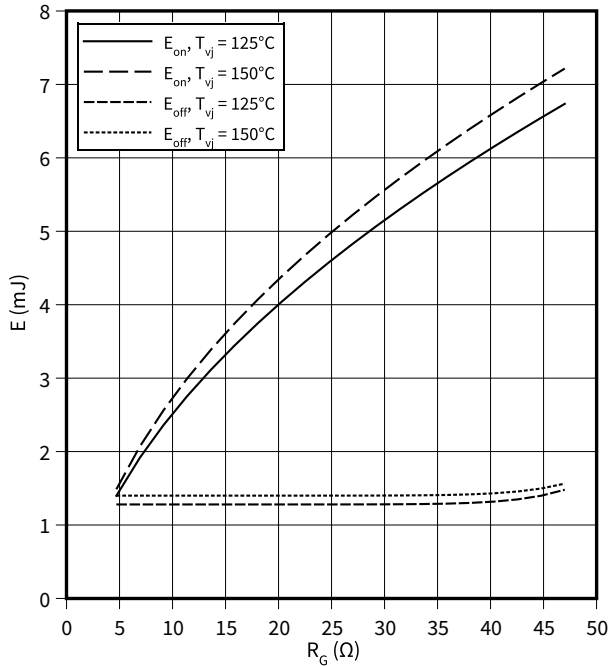

**switching times (typical), IGBT, T1.1 / T1.2 / T4.1 / T4.2**

$t = f(I_C)$

$R_{Goff} = 4.7 \text{ } \Omega, R_{Gon} = 4.7 \text{ } \Omega, V_{CE} = 300 \text{ V}, V_{GE} = \pm 15 \text{ V}, T_{vj} = 150 \text{ } ^\circ\text{C}$

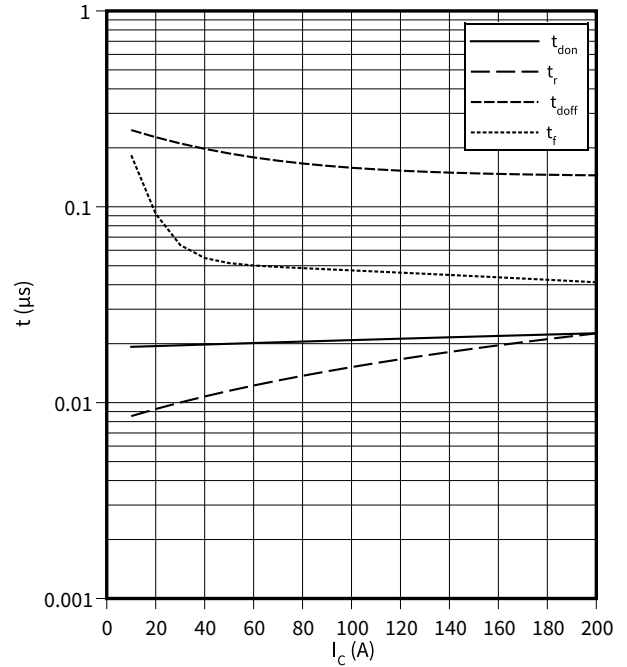

**switching times (typical), IGBT, T1.1 / T1.2 / T4.1 / T4.2**

$t = f(R_G)$

$I_C = 100 \text{ A}, V_{CE} = 300 \text{ V}, V_{GE} = \pm 15 \text{ V}, T_{vj} = 150 \text{ } ^\circ\text{C}$

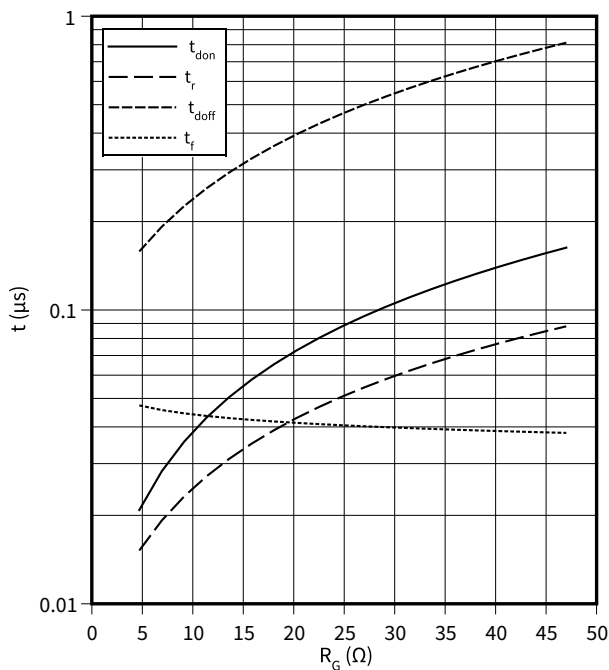

**transient thermal impedance, IGBT, T1.1 / T1.2 / T4.1 / T4.2**

$Z_{th} = f(t)$

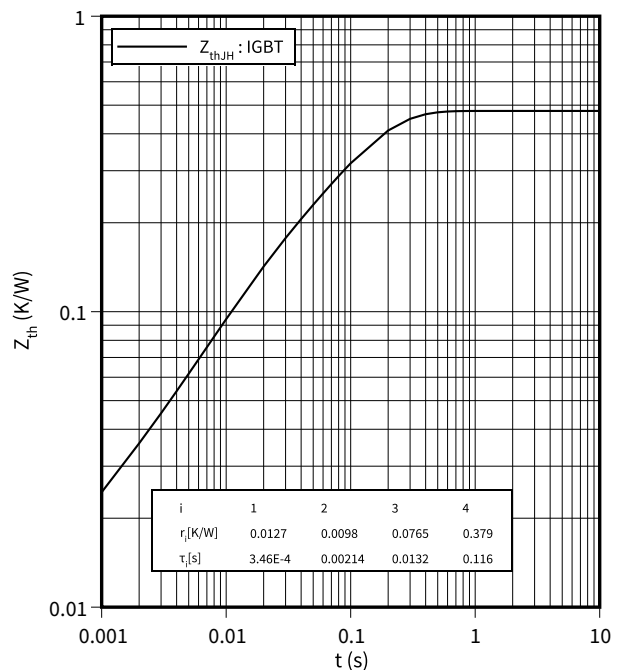

8 Characteristics diagrams

**reverse bias safe operating area (RBSOA), IGBT, T1.1 / T1.2 / T4.1 / T4.2**

$I_C = f(V_{CE})$

$R_{Goff} = 4.7 \Omega, V_{GE} = \pm 15 V, T_{vj} = 150 \text{ }^\circ\text{C}$

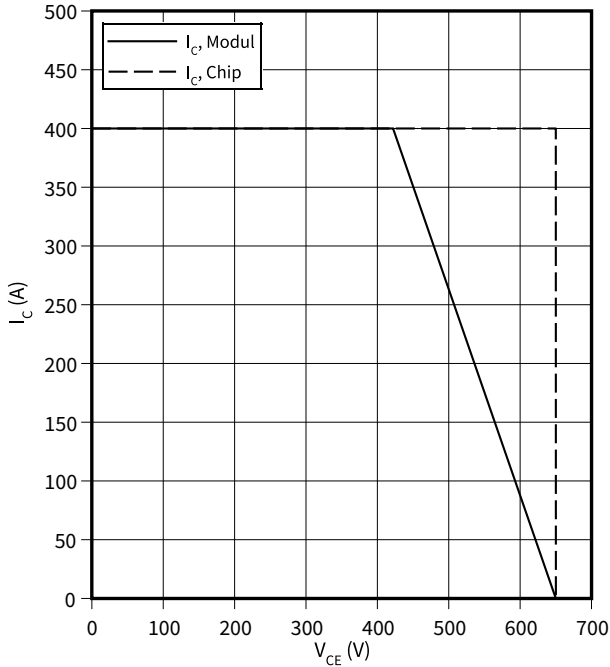

**capacity characteristic (typical), IGBT, T1.1 / T1.2 / T4.1 / T4.2**

$C = f(V_{CE})$

$f = 100 \text{ kHz}, V_{GE} = 0 V, T_{vj} = 25 \text{ }^\circ\text{C}$

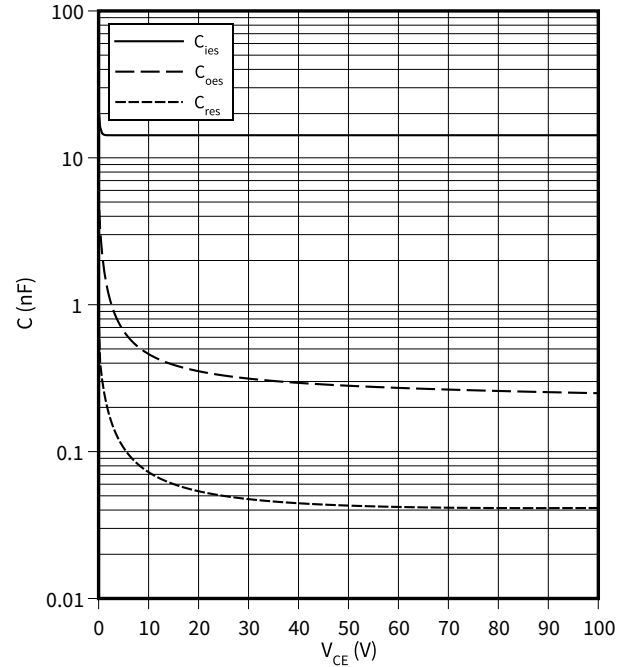

**gate charge characteristic (typical), IGBT, T1.1 / T1.2 / T4.1 / T4.2**

$V_{GE} = f(Q_G)$

$I_C = 200 \text{ A}, T_{vj} = 25 \text{ }^\circ\text{C}$

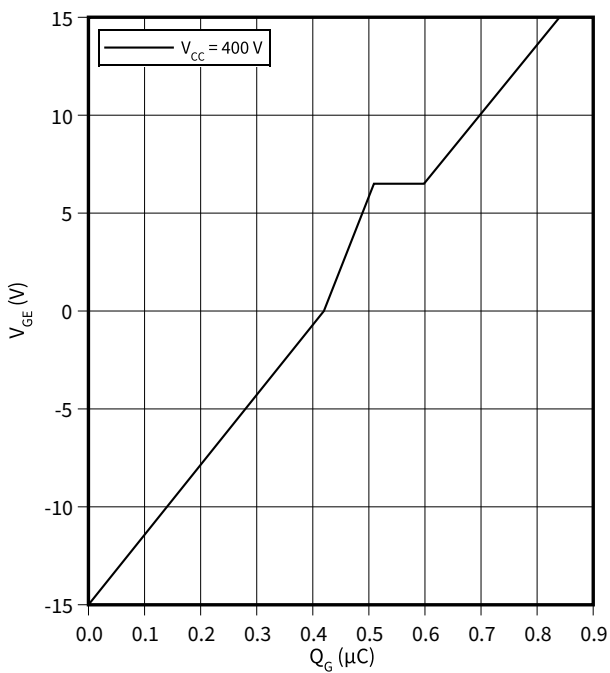

**output characteristic (typical), IGBT, T2 / T3**

$I_C = f(V_{CE})$

$V_{GE} = 15 \text{ V}$

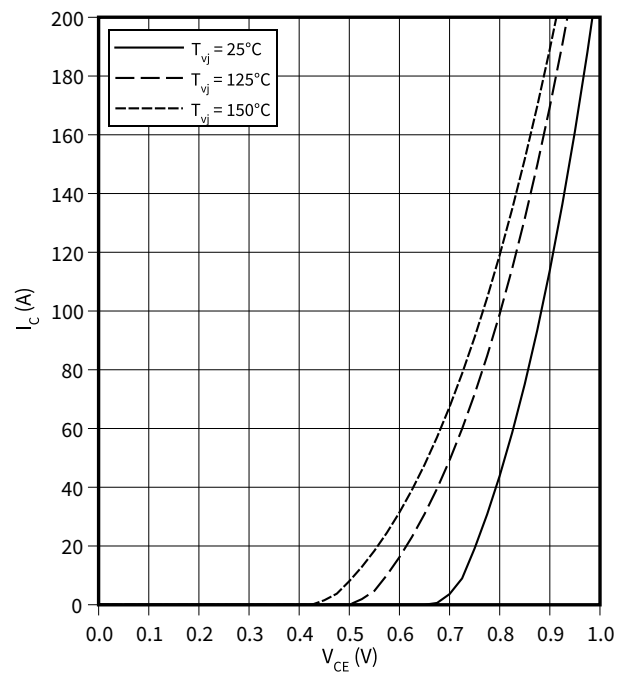

8 Characteristics diagrams

**output characteristic (typical), IGBT, T2 / T3**

$I_C = f(V_{CE})$   
 $T_{vj} = 150\text{ °C}$

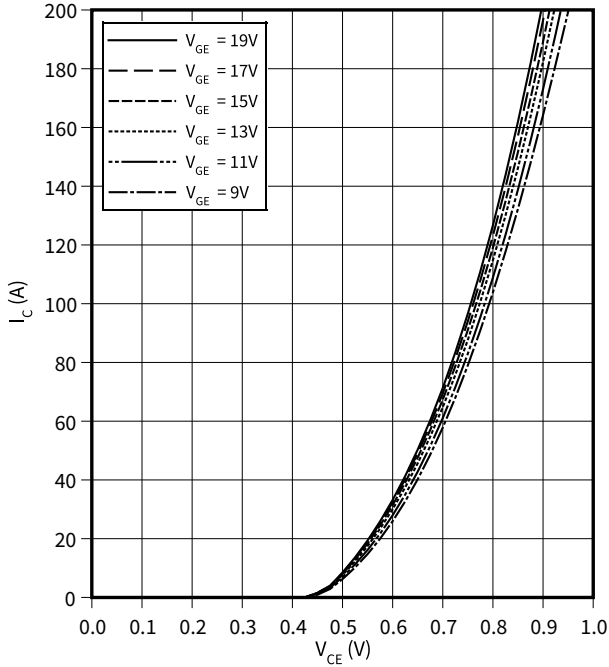

**transfer characteristic (typical), IGBT, T2 / T3**

$I_C = f(V_{GE})$   
 $V_{CE} = 20\text{ V}$

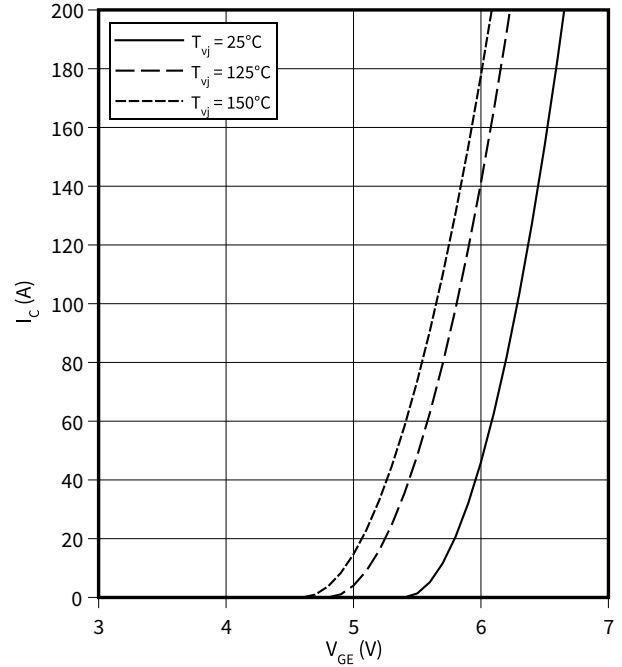

**switching losses (typical), IGBT, T2 / T3**

$E = f(I_C)$   
 $R_{Goff} = 6.8\ \Omega$ ,  $R_{Gon} = 6.8\ \Omega$ ,  $V_{CE} = 300\text{ V}$ ,  $V_{GE} = \pm 15\text{ V}$

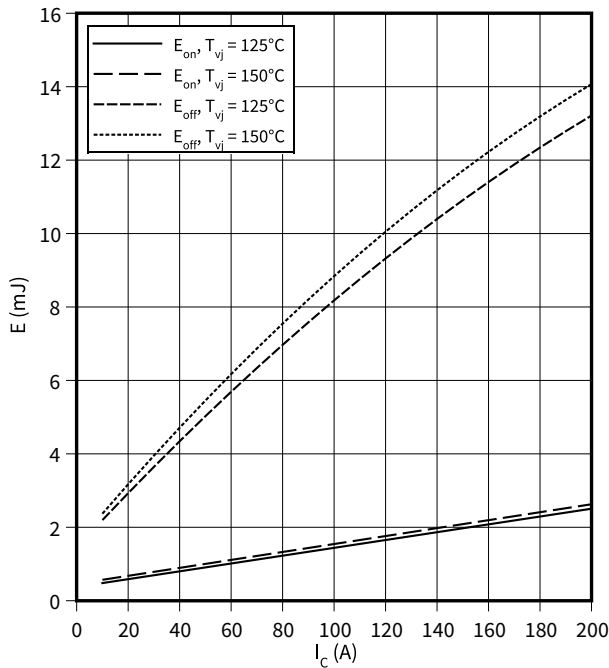

**switching losses (typical), IGBT, T2 / T3**

$E = f(R_G)$   
 $I_C = 100\text{ A}$ ,  $V_{CE} = 300\text{ V}$ ,  $V_{GE} = \pm 15\text{ V}$

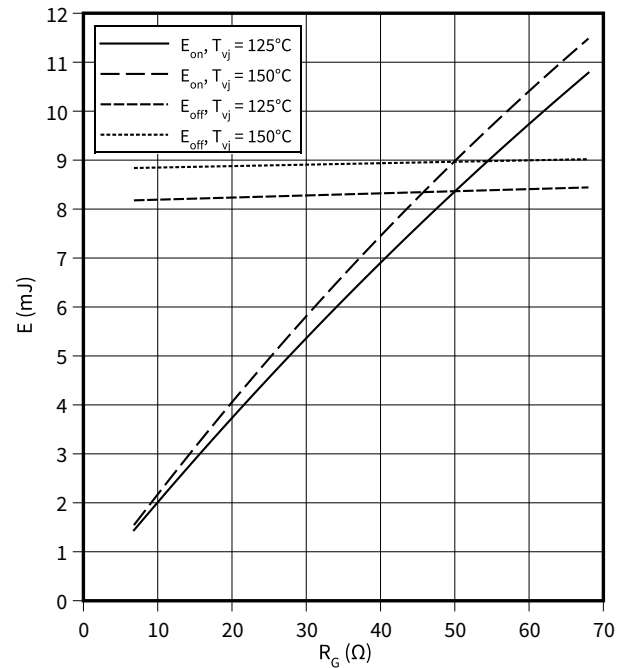

8 Characteristics diagrams

**switching times (typical), IGBT, T2 / T3**

$t = f(I_C)$

$R_{Goff} = 6.8 \Omega$ ,  $R_{Gon} = 6.8 \Omega$ ,  $V_{CE} = 300 \text{ V}$ ,  $V_{GE} = \pm 15 \text{ V}$ ,  $T_{vj} = 150 \text{ }^\circ\text{C}$

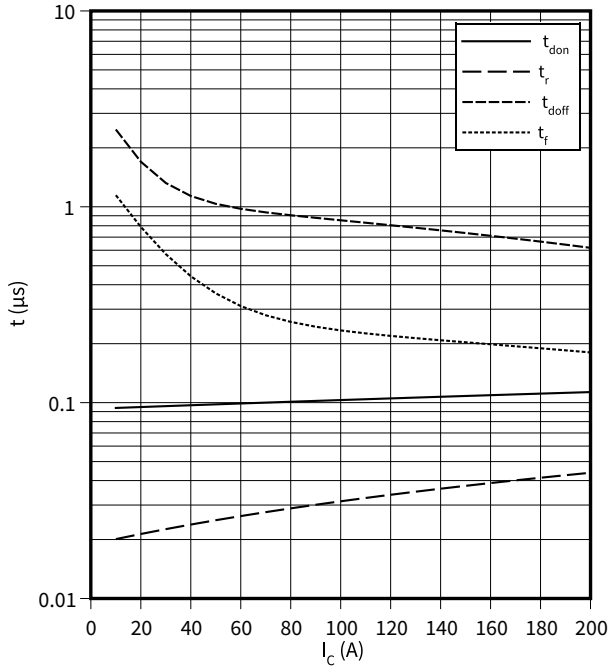

**switching times (typical), IGBT, T2 / T3**

$t = f(R_G)$

$I_C = 100 \text{ A}$ ,  $V_{CE} = 300 \text{ V}$ ,  $V_{GE} = \pm 15 \text{ V}$ ,  $T_{vj} = 150 \text{ }^\circ\text{C}$

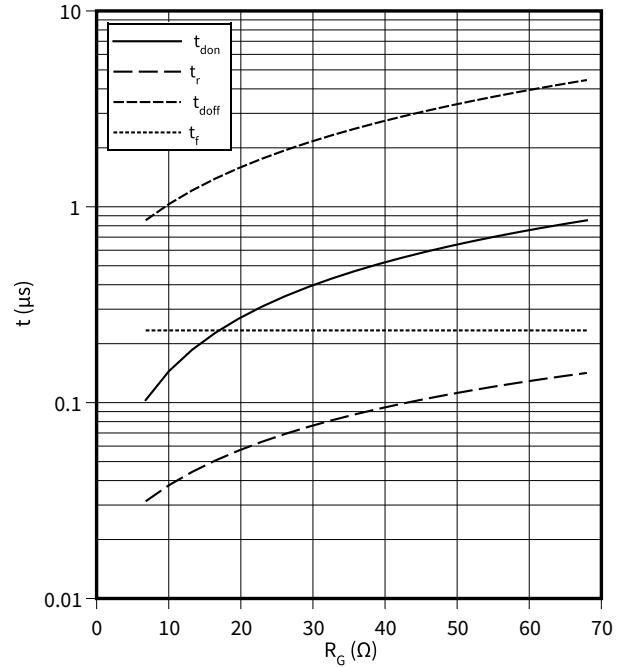

**transient thermal impedance, IGBT, T2 / T3**

$Z_{th} = f(t)$

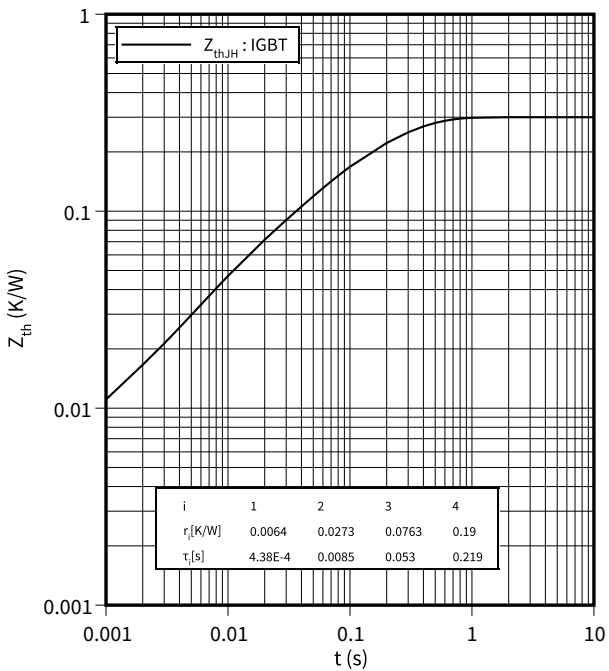

**reverse bias safe operating area (RBSOA), IGBT, T2 / T3**

$I_C = f(V_{CE})$

$R_{Goff} = 6.8 \Omega$ ,  $V_{GE} = \pm 15 \text{ V}$ ,  $T_{vj} = 150 \text{ }^\circ\text{C}$

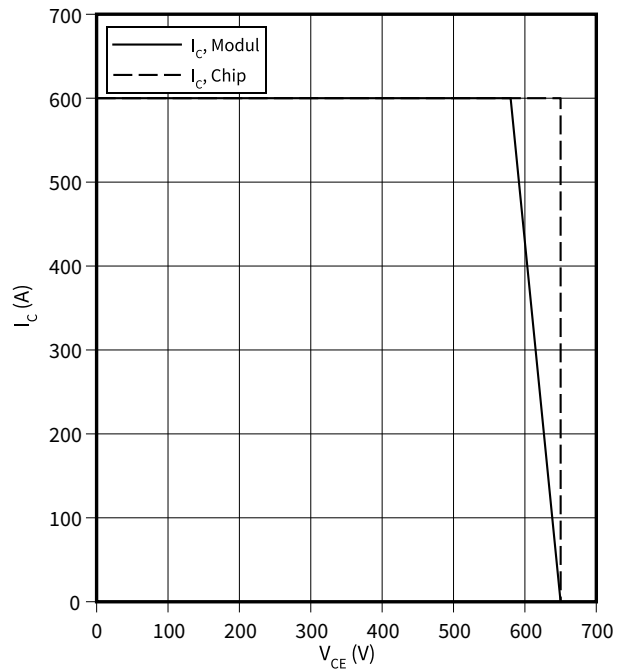

8 Characteristics diagrams

**capacity characteristic (typical), IGBT, T2 / T3**

$C = f(V_{CE})$

$f = 100 \text{ kHz}, V_{GE} = 0 \text{ V}, T_{vj} = 25 \text{ }^\circ\text{C}$

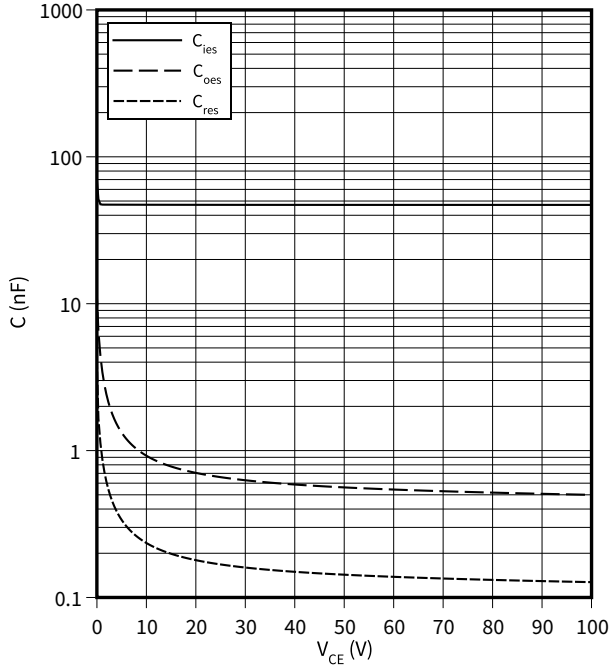

**gate charge characteristic (typical), IGBT, T2 / T3**

$V_{GE} = f(Q_G)$

$I_C = 200 \text{ A}, T_{vj} = 25 \text{ }^\circ\text{C}$

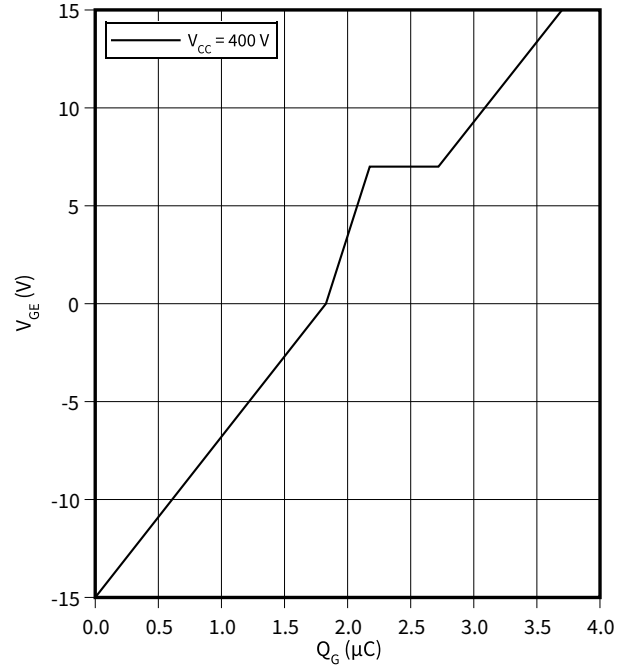

**forward characteristic (typical), Diode, D1 / D4**

$I_F = f(V_F)$

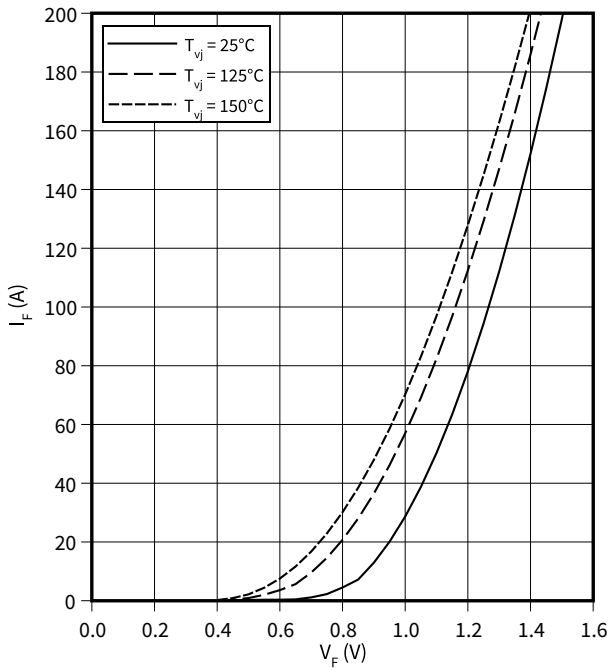

**switching losses (typical), Diode, D1 / D4**

$E_{rec} = f(I_F)$

$R_{Gon} = 6.8 \text{ } \Omega, V_{CE} = 300 \text{ V}$

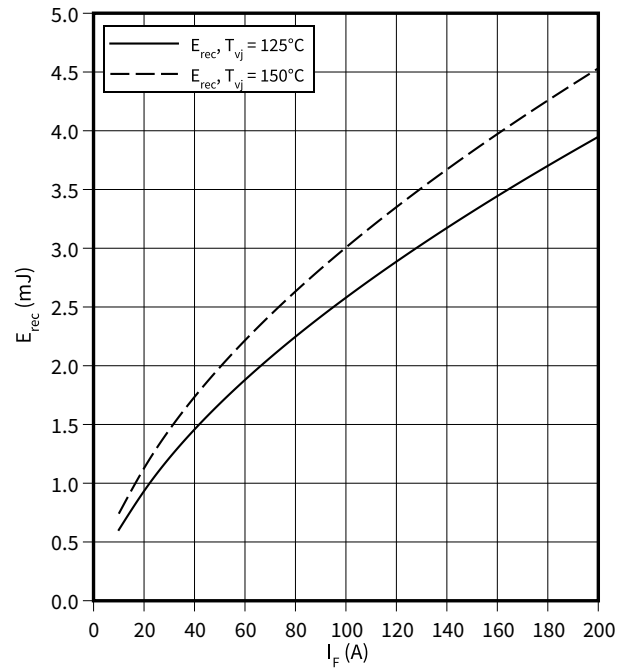



8 Characteristics diagrams

**switching losses (typical), Diode, D1 / D4**

$E_{rec} = f(R_G)$

$V_{CE} = 300\text{ V}, I_F = 100\text{ A}$

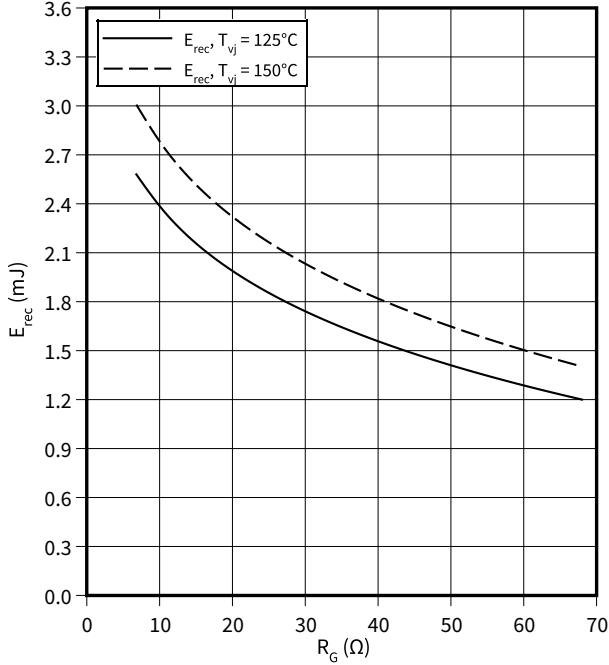

**transient thermal impedance, Diode, D1 / D4**

$Z_{th} = f(t)$

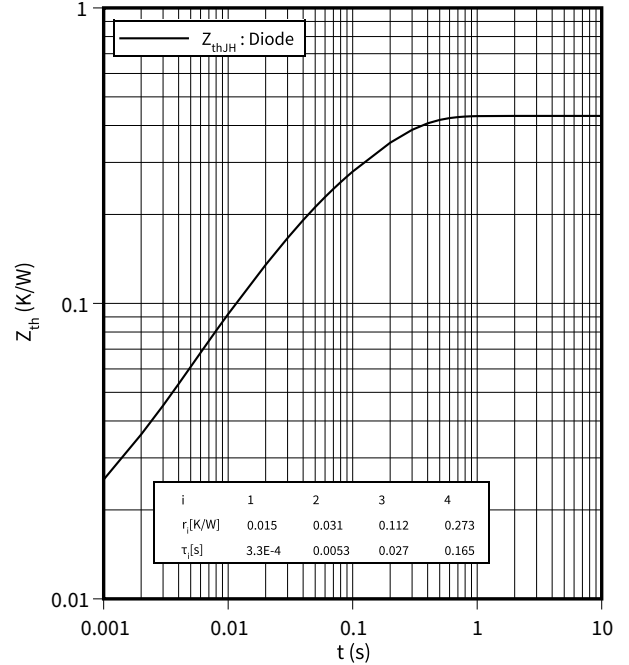

**forward characteristic (typical), Diode, D2 / D3**

$I_F = f(V_F)$

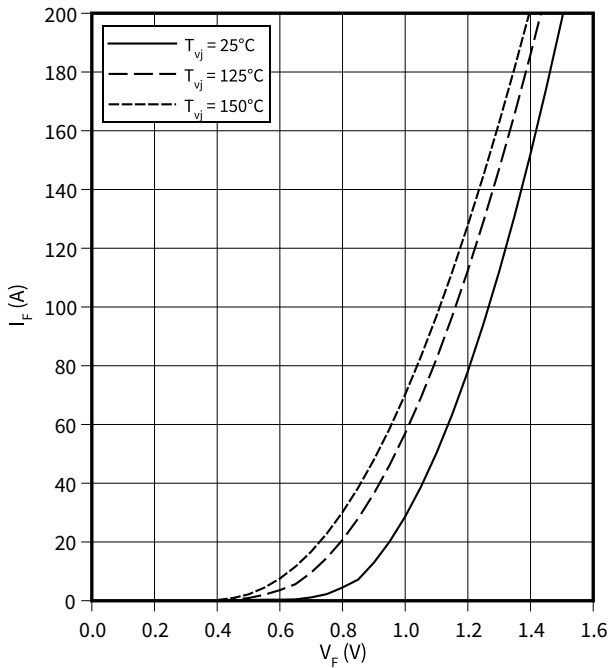

**switching losses (typical), Diode, D2 / D3**

$E_{rec} = f(I_F)$

$R_{Gon} = 6.8\ \Omega, V_{CE} = 300\text{ V}$

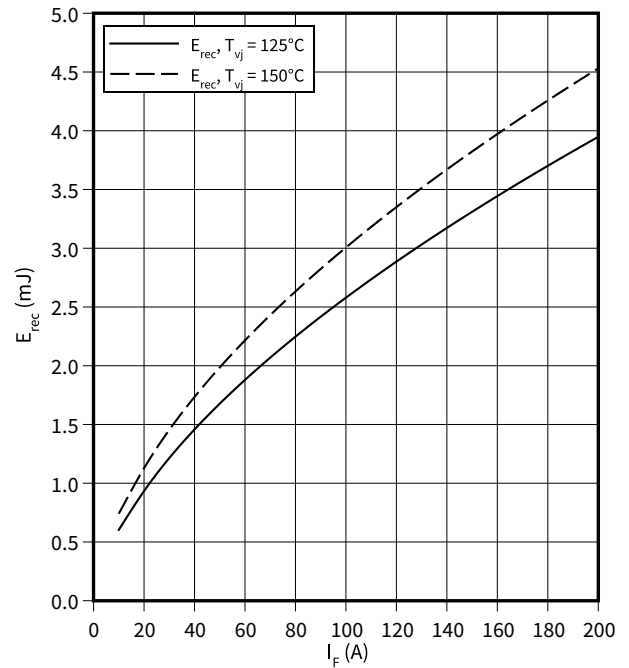

8 Characteristics diagrams

**switching losses (typical), Diode, D2 / D3**

$E_{rec} = f(R_G)$

$V_{CE} = 300\text{ V}, I_F = 100\text{ A}$

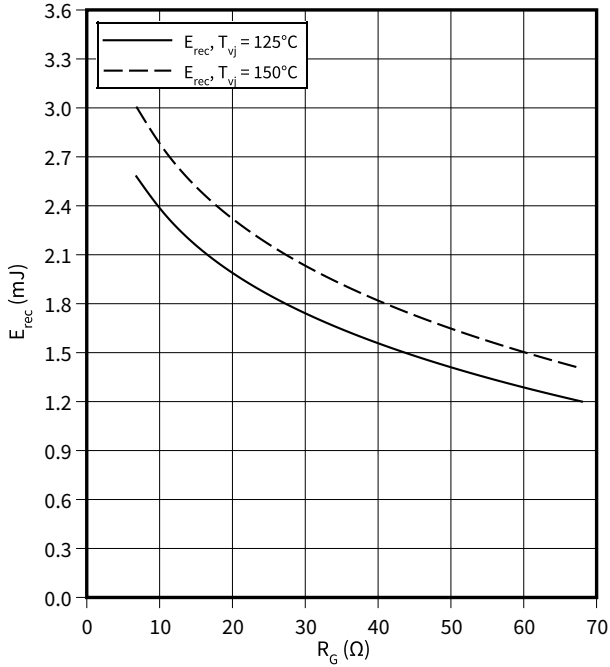

**transient thermal impedance, Diode, D2 / D3**

$Z_{th} = f(t)$

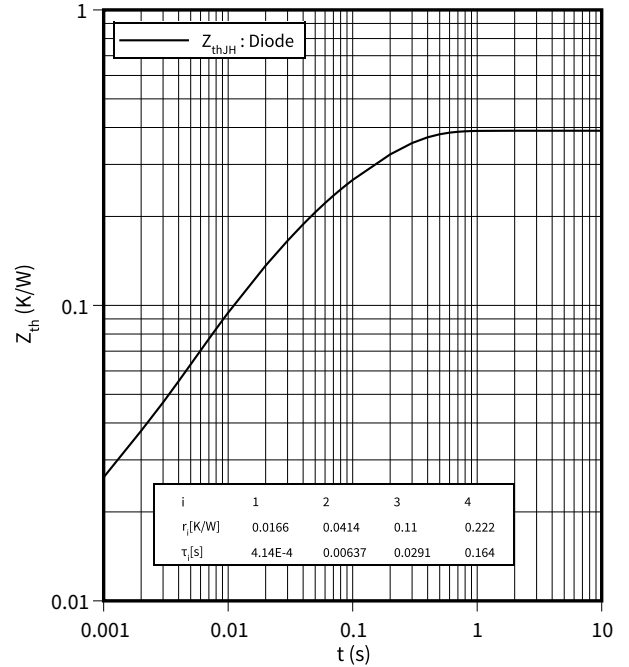

**forward characteristic of (typical), Diode, D5 / D6**

$I_F = f(V_F)$

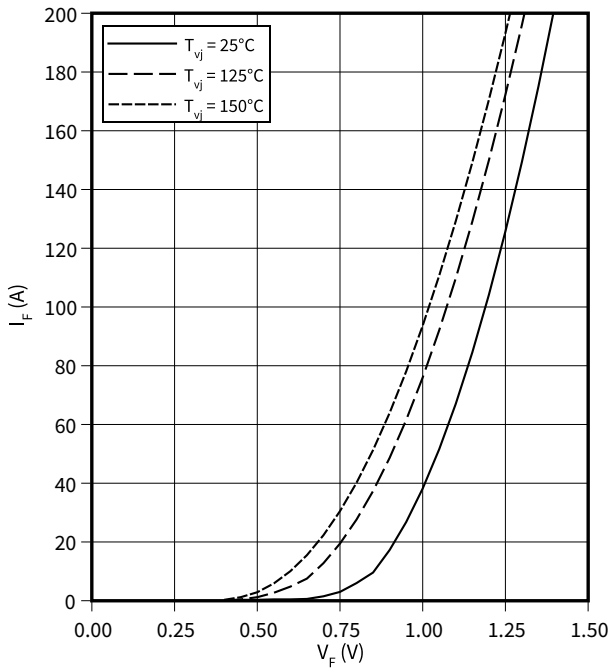

**switching losses (typical), Diode, D5 / D6**

$E_{rec} = f(I_F)$

$R_{Gon} = 4.7\ \Omega, V_{CE} = 300\text{ V}$

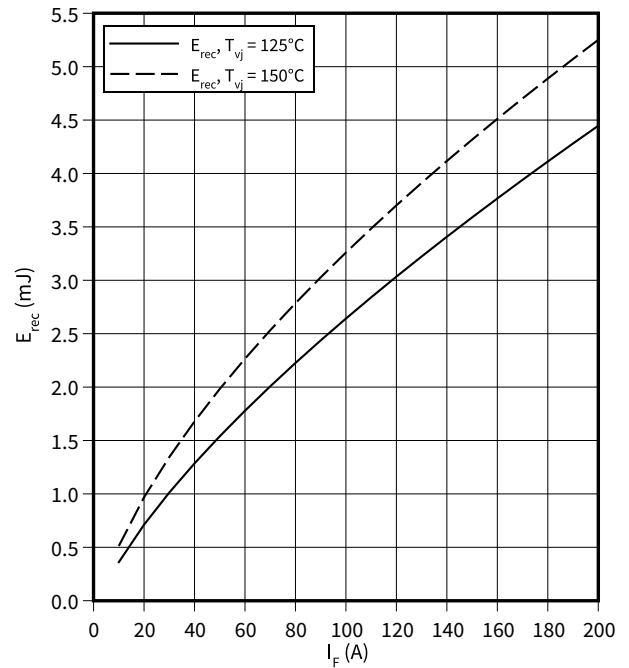

8 Characteristics diagrams

**switching losses (typical), Diode, D5 / D6**

$E_{rec} = f(R_G)$   
 $V_{CE} = 300\text{ V}, I_F = 100\text{ A}$

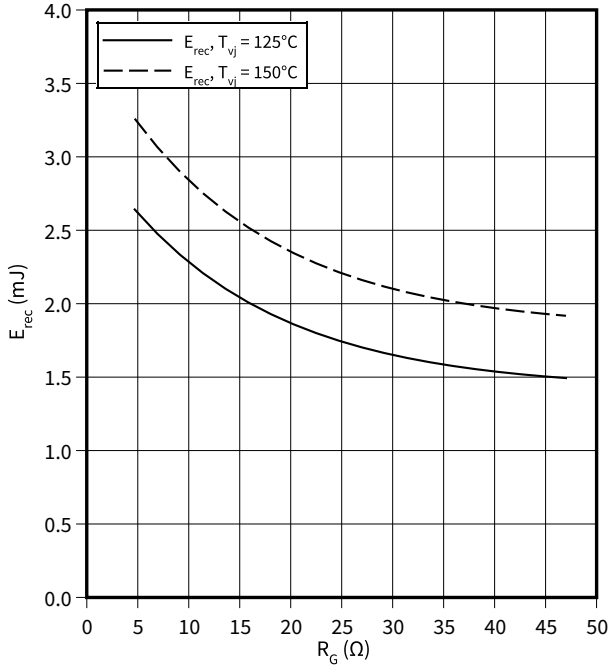

**transient thermal impedance , Diode, D5 / D6**

$Z_{th} = f(t)$

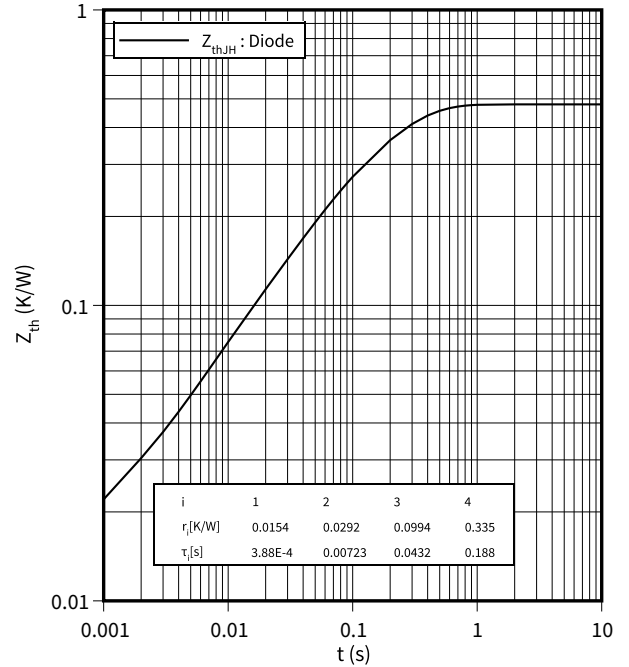

**temperature characteristic (typical), NTC-Thermistor**

$R = f(T_{NTC})$

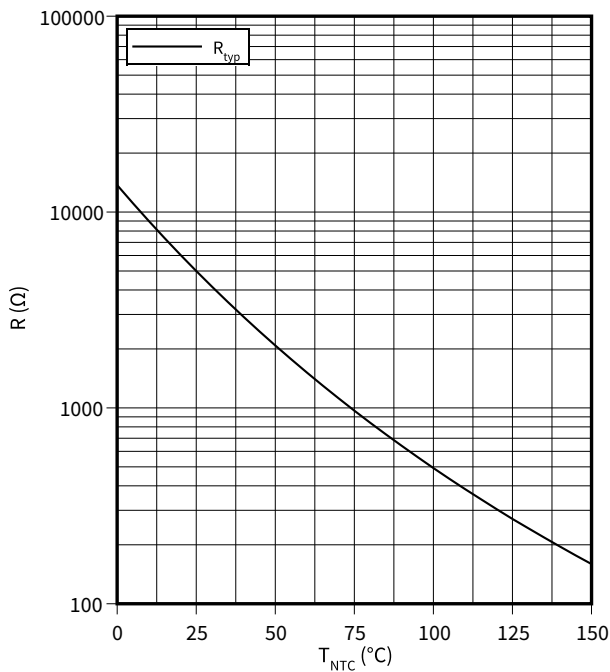

## 9 Circuit diagram

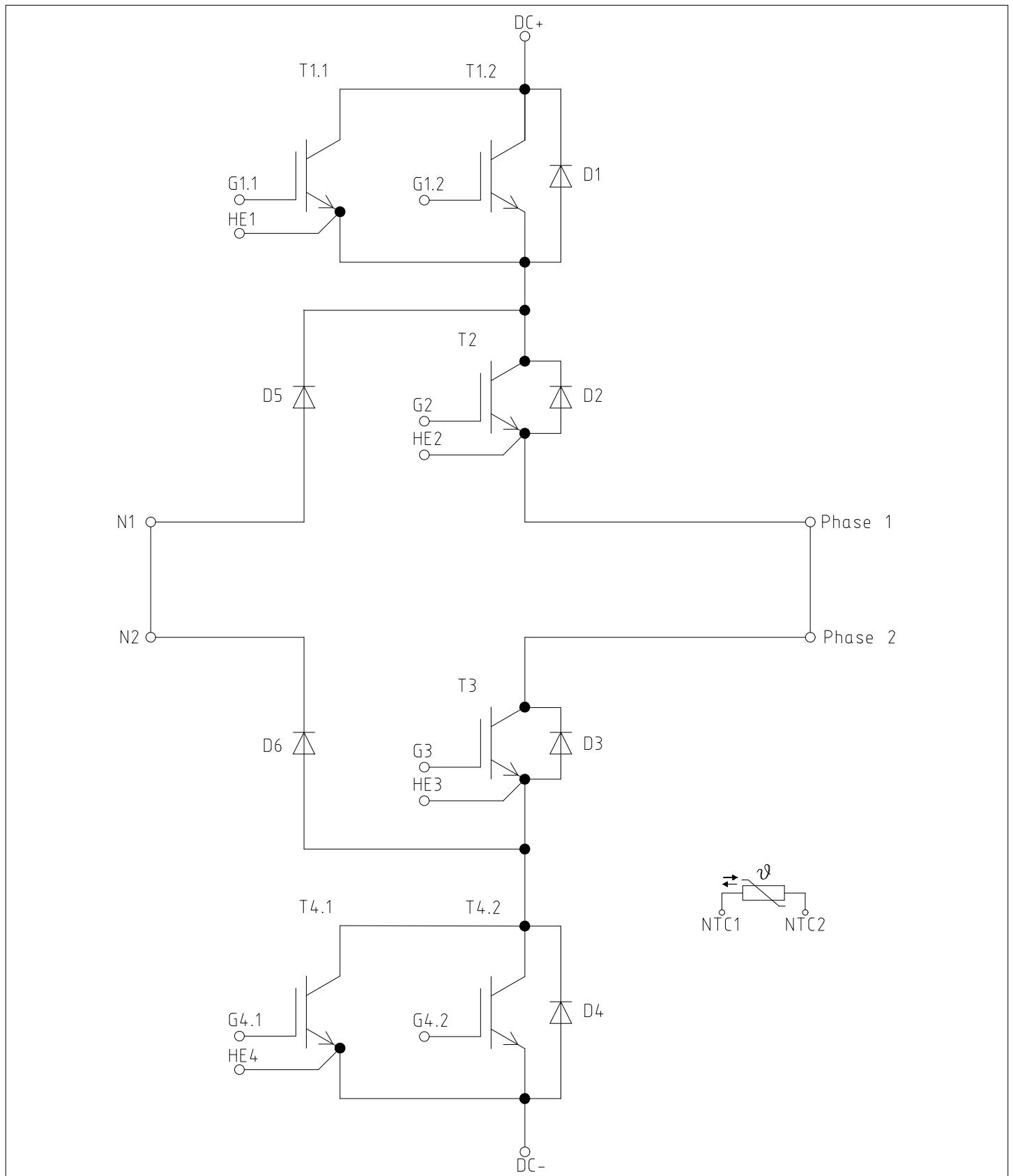

Figure 2

10 Package outlines

10 Package outlines

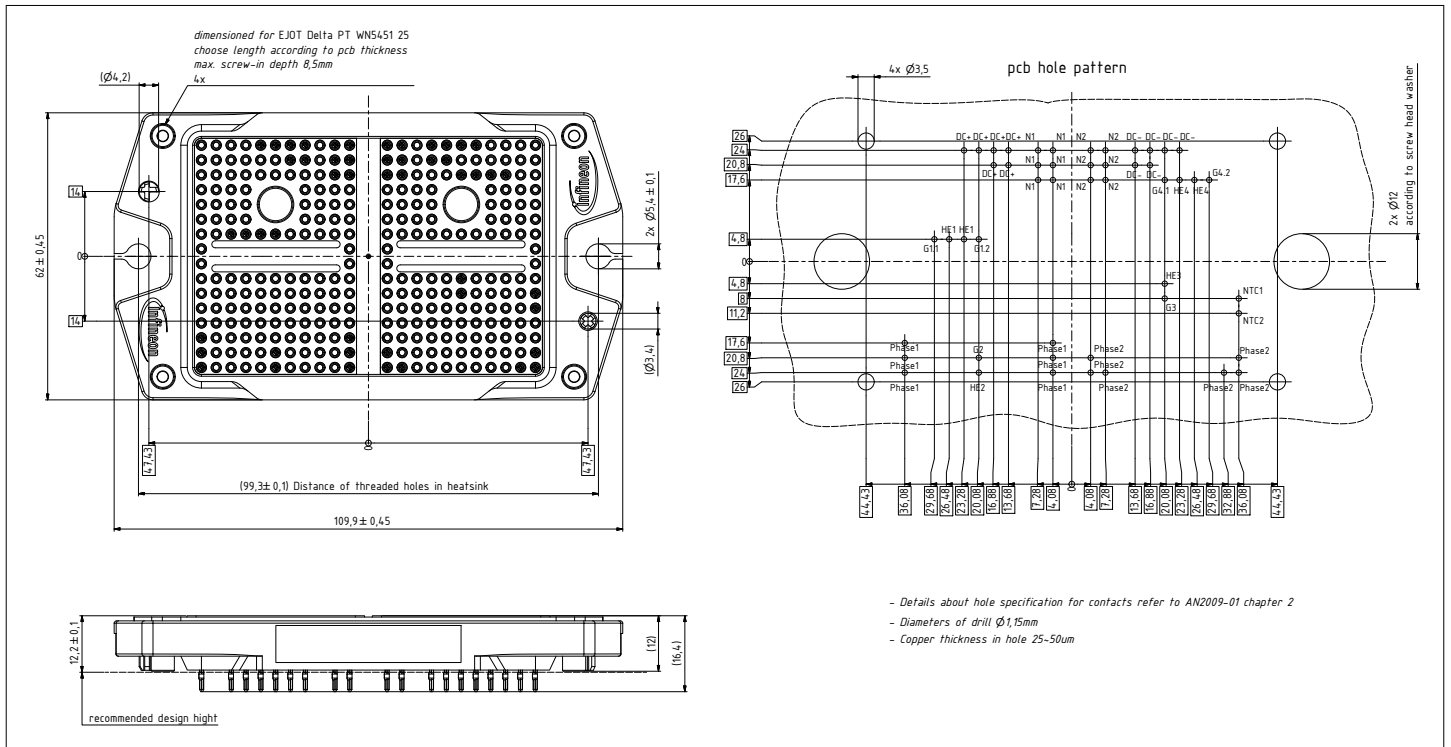

Figure 3

11 Module label code

Module label code			
Code format	Data Matrix	Barcode Code128	
Encoding	ASCII text	Code Set A	
Symbol size	16x16	23 digits	
Standard	IEC24720 and IEC16022	IEC8859-1	
Code content	<i>Content</i>	<i>Digit</i>	<i>Example</i>
	Module serial number	1 - 5	71549
	Module material number	6 - 11	142846
	Production order number	12 - 19	55054991
	Date code (production year)	20 - 21	15
	Date code (production week)	22 - 23	30
Example			
	71549142846550549911530		

Figure 4

---

Revision history

## Revision history

Document revision	Date of release	Description of changes
0.10	2021-04-28	Target datasheet
1.00	2021-06-25	Final datasheet

## Trademarks

All referenced product or service names and trademarks are the property of their respective owners.

**Edition 2021-06-25**

**Published by**

**Infineon Technologies AG**

**81726 Munich, Germany**

**© 2021 Infineon Technologies AG**

**All Rights Reserved.**

**Do you have a question about any aspect of this document?**

**Email: [erratum@infineon.com](mailto:erratum@infineon.com)**

**Document reference**

**IFX-AAS474-002**

## IMPORTANT NOTICE

The information given in this document shall in no event be regarded as a guarantee of conditions or characteristics ("Beschaffheitsgarantie").

With respect to any examples, hints or any typical values stated herein and/or any information regarding the application of the product, Infineon Technologies hereby disclaims any and all warranties and liabilities of any kind, including without limitation warranties of non-infringement of intellectual property rights of any third party.

In addition, any information given in this document is subject to customer's compliance with its obligations stated in this document and any applicable legal requirements, norms and standards concerning customer's products and any use of the product of Infineon Technologies in customer's applications.

The data contained in this document is exclusively intended for technically trained staff. It is the responsibility of customer's technical departments to evaluate the suitability of the product for the intended application and the completeness of the product information given in this document with respect to such application.

Please note that this product is not qualified according to the AEC Q100 or AEC Q101 documents of the Automotive Electronics Council.

## WARNINGS

Due to technical requirements products may contain dangerous substances. For information on the types in question please contact your nearest Infineon Technologies office.

Except as otherwise explicitly approved by Infineon Technologies in a written document signed by authorized representatives of Infineon Technologies, Infineon Technologies' products may not be used in any applications where a failure of the product or any consequences of the use thereof can reasonably be expected to result in personal injury.

# Mouser Electronics

Authorized Distributor

Click to View Pricing, Inventory, Delivery & Lifecycle Information:

[Infineon:](#)

[F3L400R07W3S5B59BPSA1](#)